



IABU Headquarters

Delta Electronics, Inc.
Taoyuan1
31-1, Xingbang Road, Guishan Industrial Zone,
Taoyuan County 33370, Taiwan, R.O.C.
TEL: 886-3-362-6301 / FAX: 886-3-362-7267

ASIA

Delta Electronics (Jiang Su) Ltd.
Wujiang Plant3
1688 Jiangxing East Road,
Wujiang Economy Development Zone,
Wujiang City, Jiang Su Province,
People's Republic of China (Post code: 215200)
TEL: 86-512-6340-3008 / FAX: 86-512-6340-7290

Delta Greentech (China) Co., Ltd.
238 Min-Xia Road, Cao-Lu Industry Zone, Pudong, Shanghai,
People's Republic of China
Post code : 201209
TEL: 021-58635678 / FAX: 021-58630003

Delta Electronics (Japan), Inc.
Tokyo Office
Delta Shibadaimon Building, 2-1-14
Shibadaimon, Minato-Ku, Tokyo, 105-0012,
Japan
TEL: 81-3-5733-1111 / FAX: 81-3-5733-1211

Europe

Deltronics (The Netherlands) B.V.
Eindhoven Office
De Witbogt 15, 5652 AG Eindhoven, The Netherlands
TEL: 31-40-2592850 / FAX: 31-40-2592851

107392, .7, .309
/ : (495) 661-24-41
E-mail: sales@deltronics.ru
http://www.deltronics.ru



DVP-ES2

Новые ПЛК для цикловой автоматики!



16ES2

8
8



20EX2

8 ,4
6 ,2



24ES2

16
8

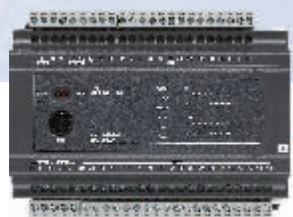

32ES2

16
16



40ES2

24
16

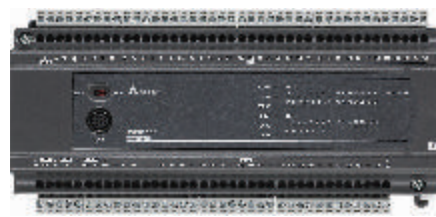

60ES2

36
24

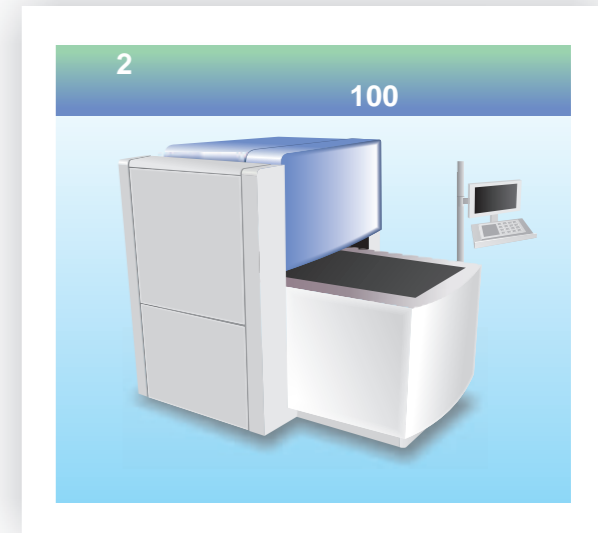
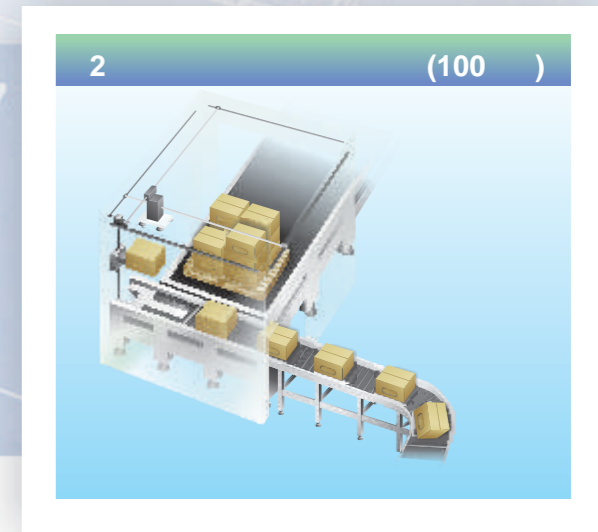
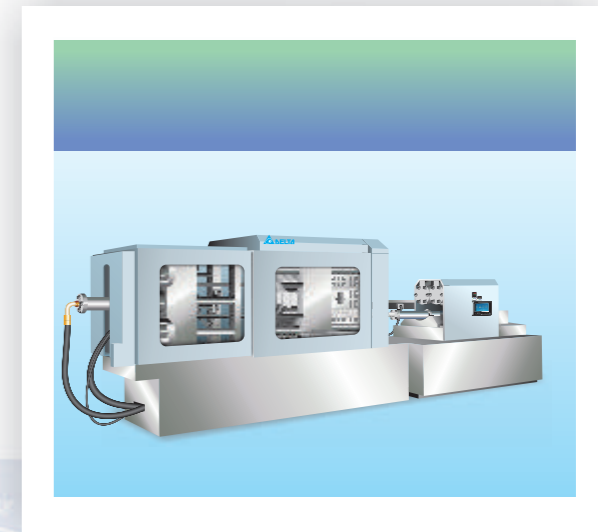
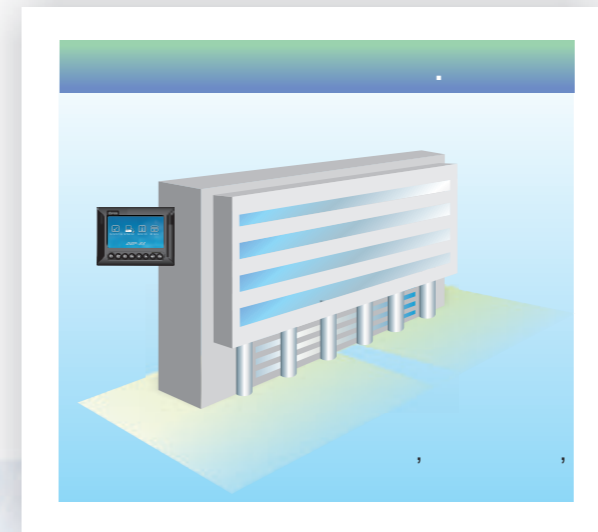

/

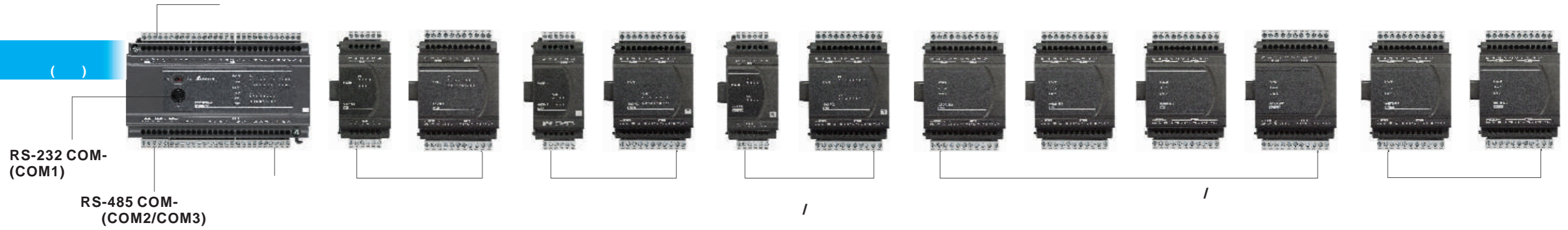

DVP-ES

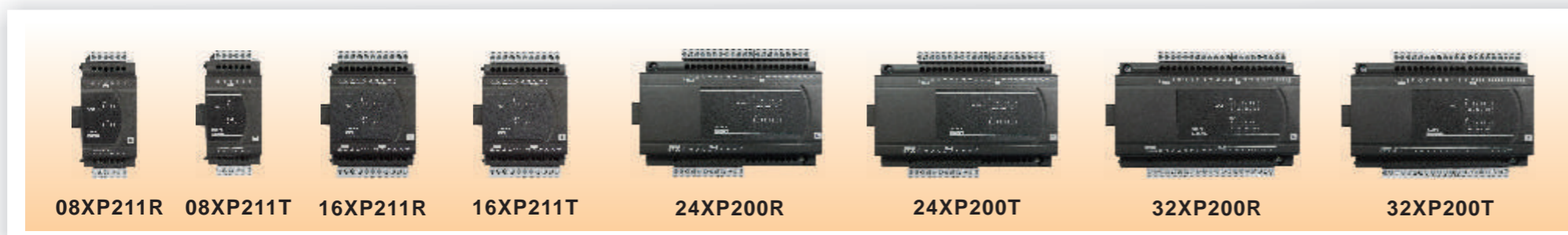

	20EX200T 20EX200R	16ES200T 16ES200R	24ES200T 24ES200R	32ES200T 32ES200R	40ES200T 40ES200R	60ES200T 60ES200R
	2	100 ; 6	10 ; .4	.8		
		2	100 ; 2	10		
			8			
			8			
		1	RS-232	2	RS-485	
				8		
					: 0.35 ... 1	
			16k			
		256	+ 16	16	256	

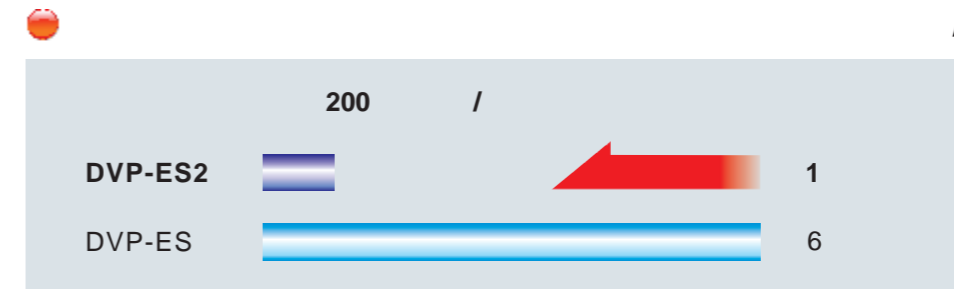

/ DVP-ES2
5 , 200 / - i

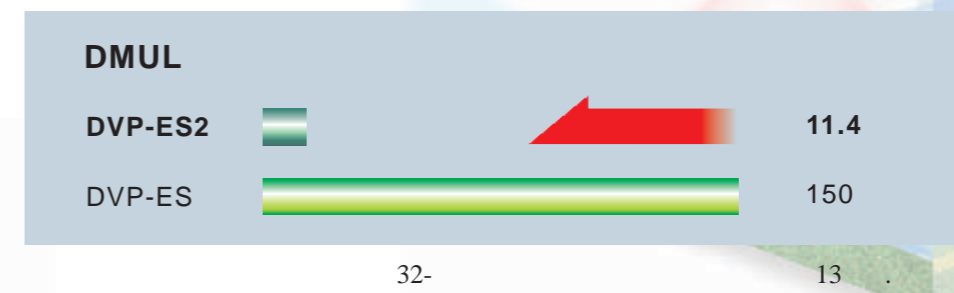
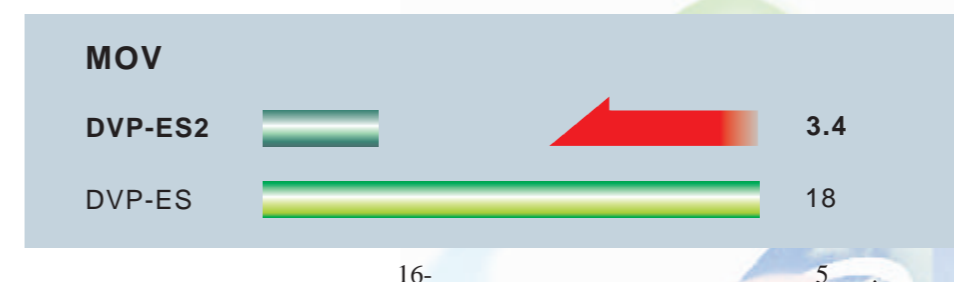
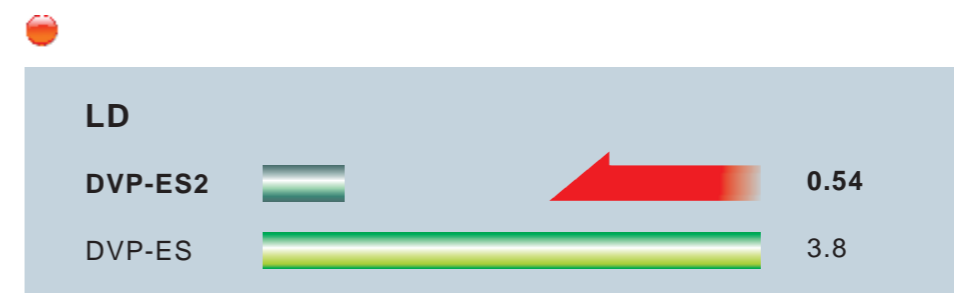

DVP-ES2 8 (2 100 6 10)

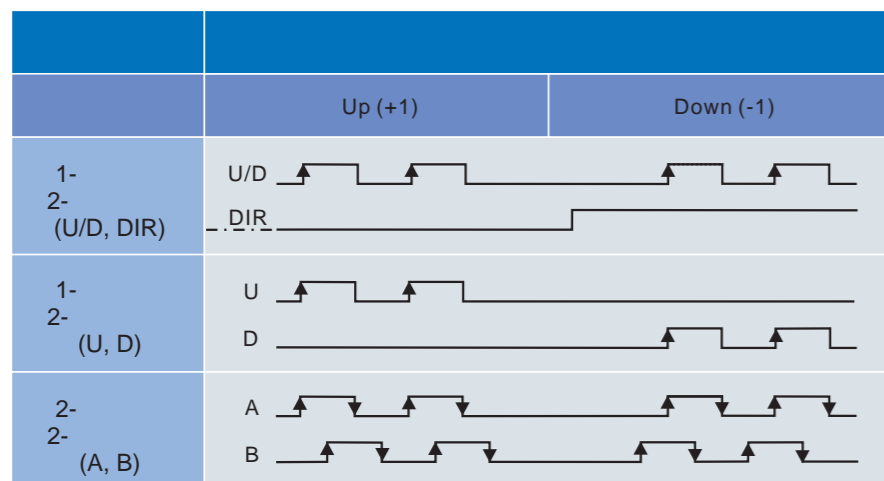

D1022 2 4

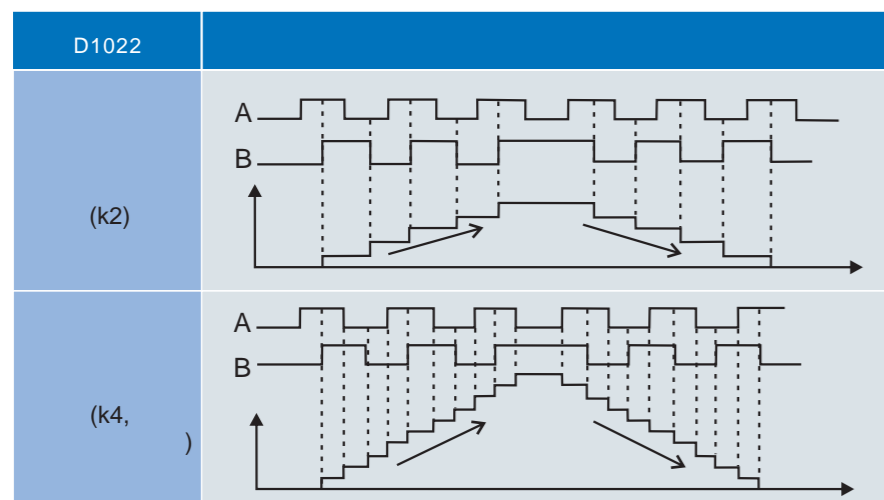

	1-	1-	1- 2-				2- 2-					
	C243	C244	C245	C246	C247	C248	C249	C250	C251	C252	C253	C254
X0	U		U/D	U/D	U	U			A	A		
X1	R		Dir	Dir	D	D			B	B		
X2		U					U/D	U/D			A	A
X3		R					Dir	Dir			B	B
X4				R		R				R		
X5								R				R

DVP-ES2 4 (2 100 2 10) : Pulse/Dir (/), A/B CW/CCW.

	D1220				D1221				
	K0	K1	K2	K3	K0	K1	K2	K3	
Y0	Pulse		Pulse	A	CW				
Y1		Pulse	Dir	B					
Y2					Pulse		Pulse	A	CCW
Y3						Pulse	Dir	B	

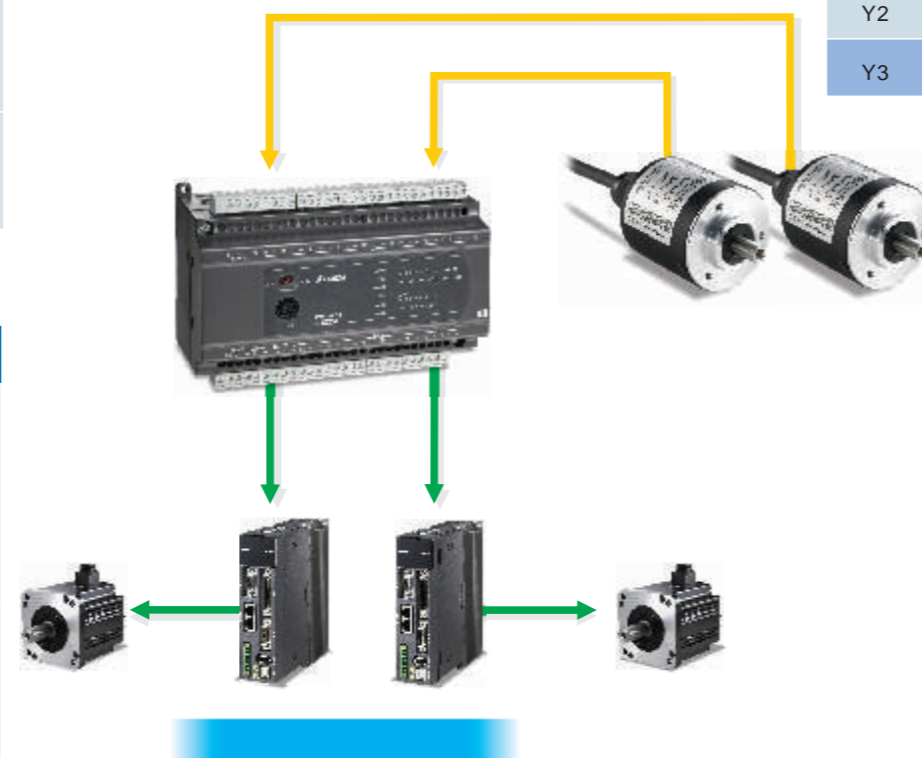

(DHSCS DHSCR)

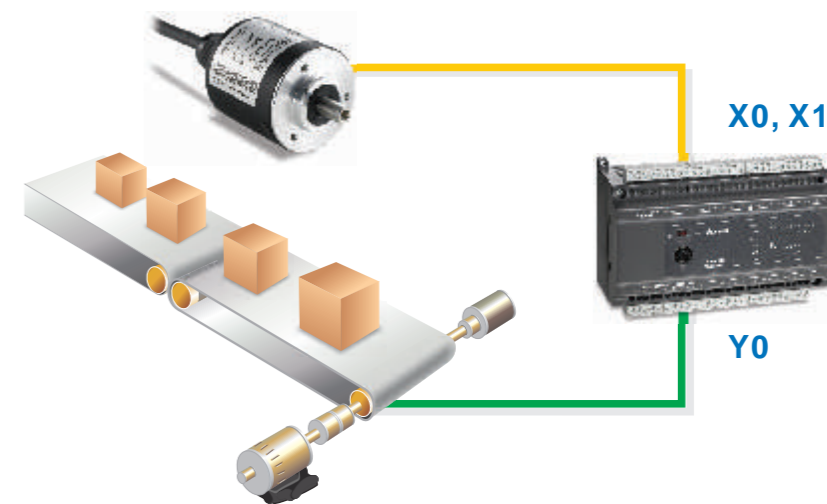

DVP-ES2 2 4

	A				B			
	A1	A2	A3	A4	B1	B2	B3	B4
	C243, C245-C248, C251, C252				C244, C249, C250, C253, C254			
	I010	I020	I030	I040	I050	I060	I070	I080
	4 A				4 B			

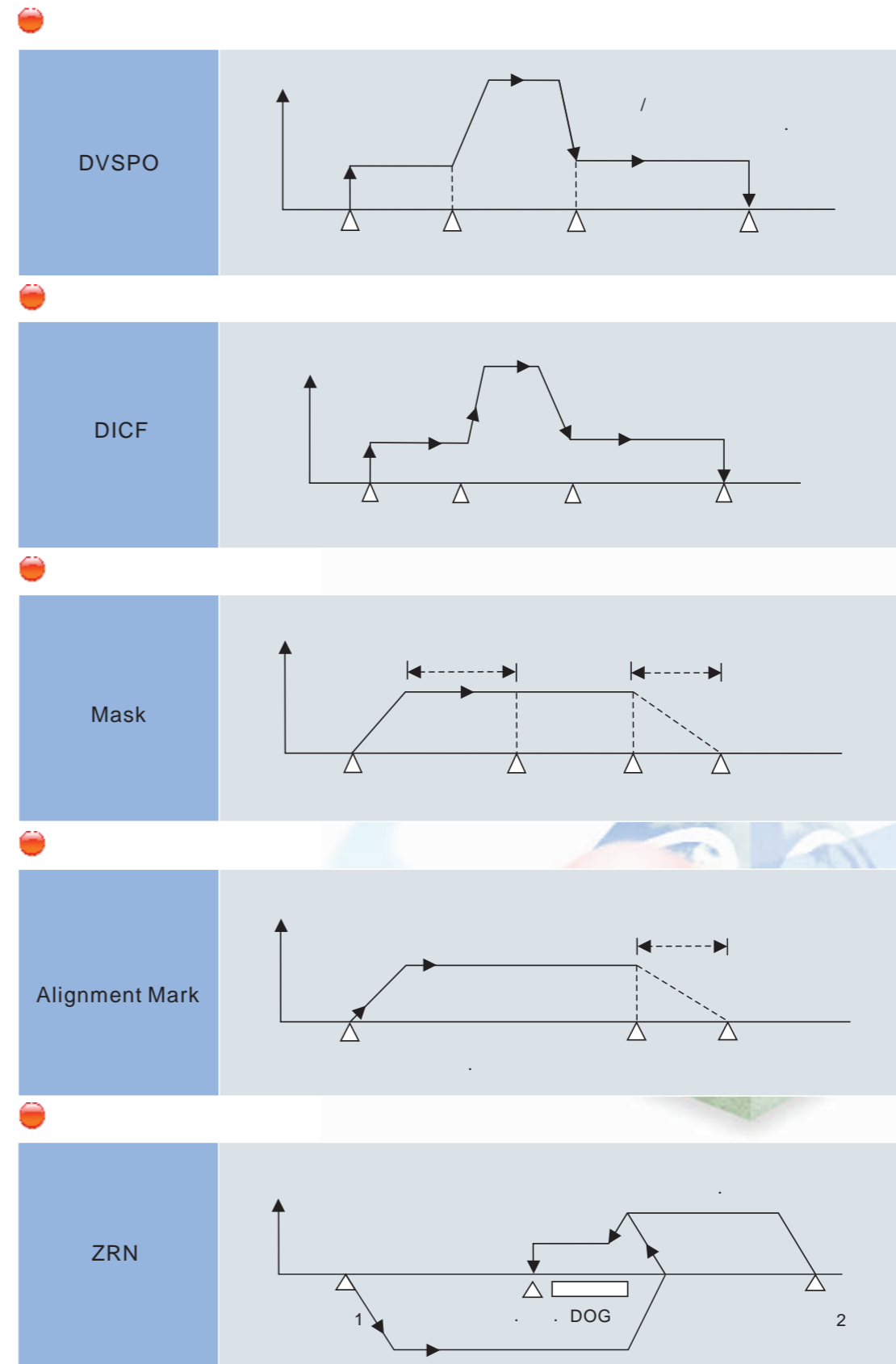
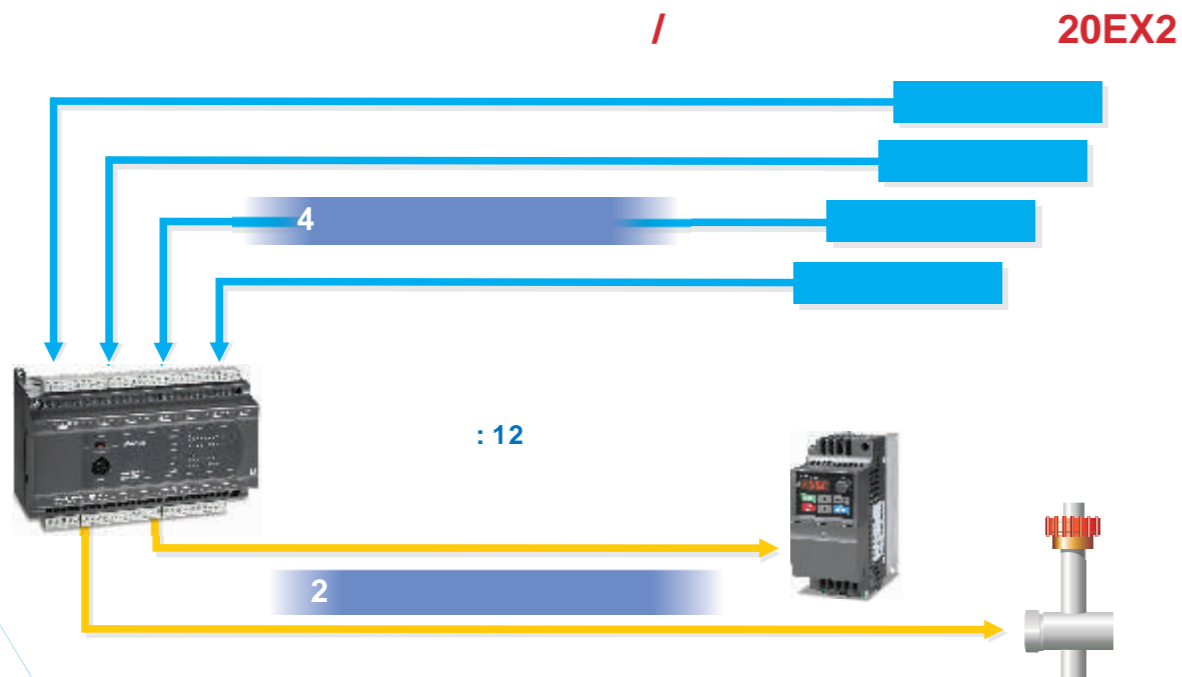
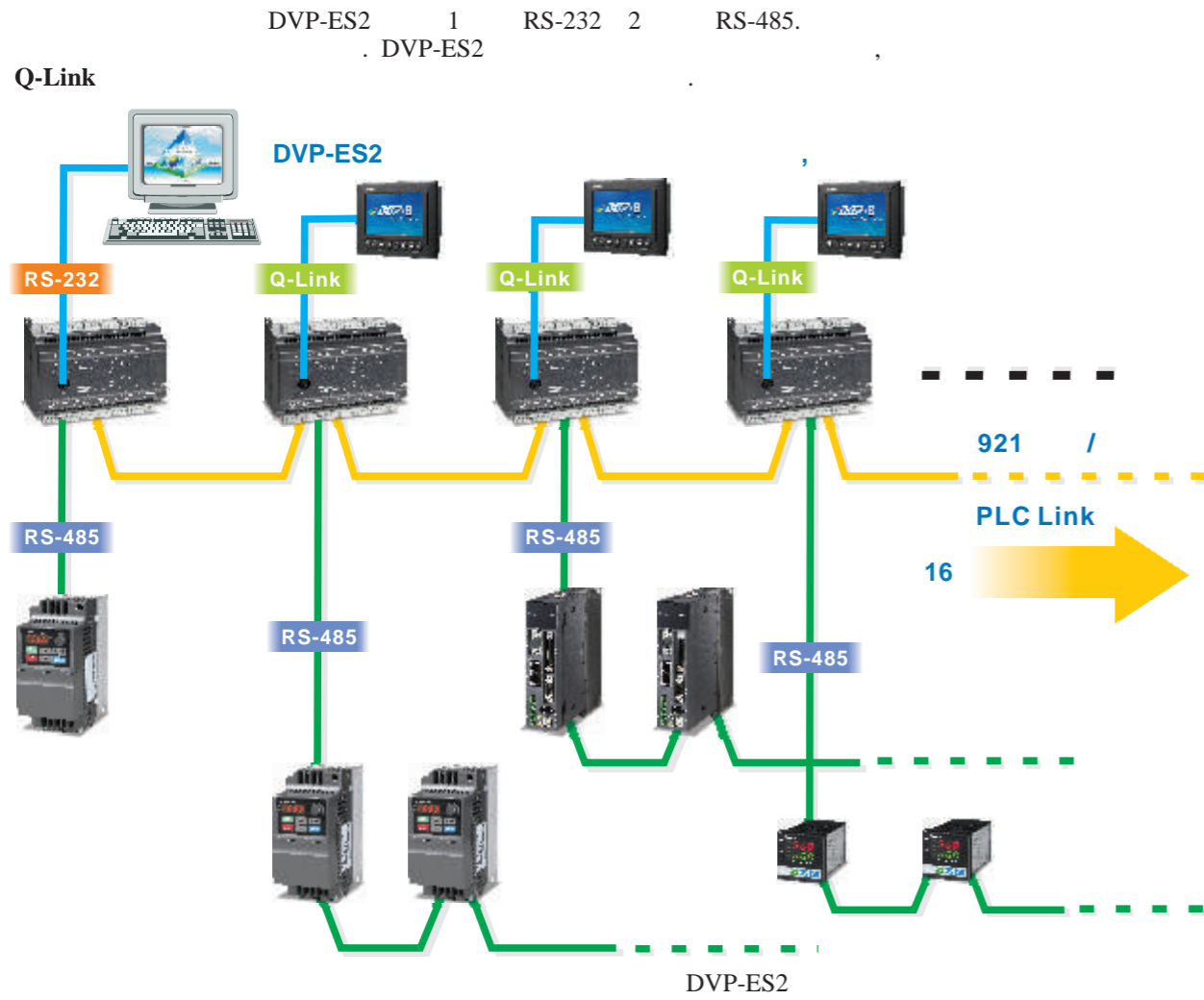

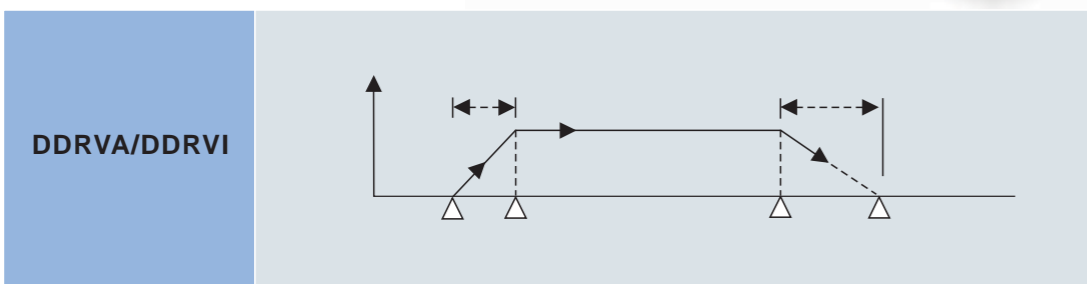
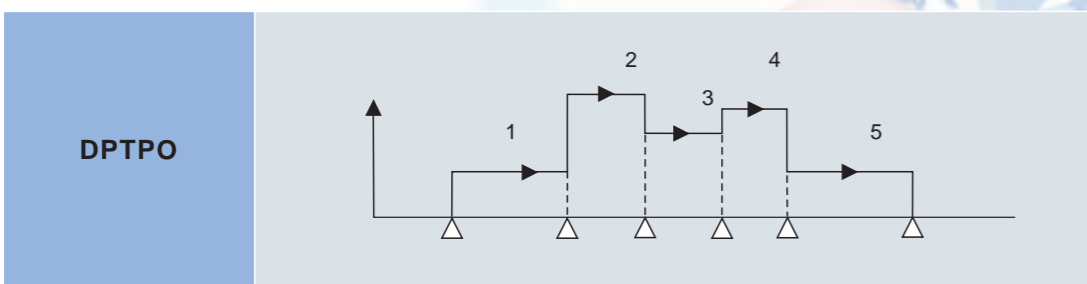
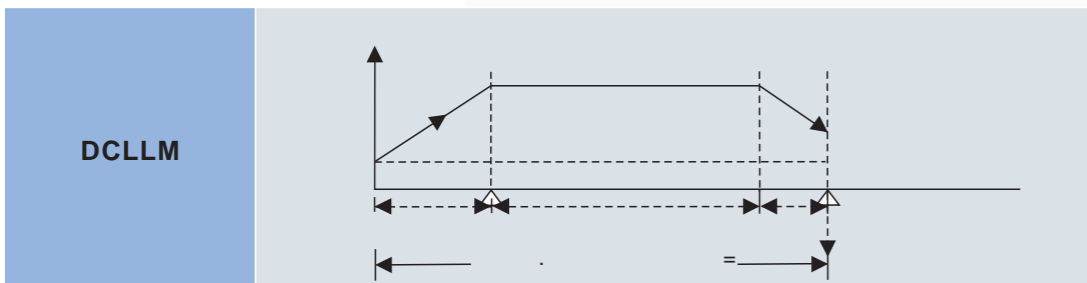
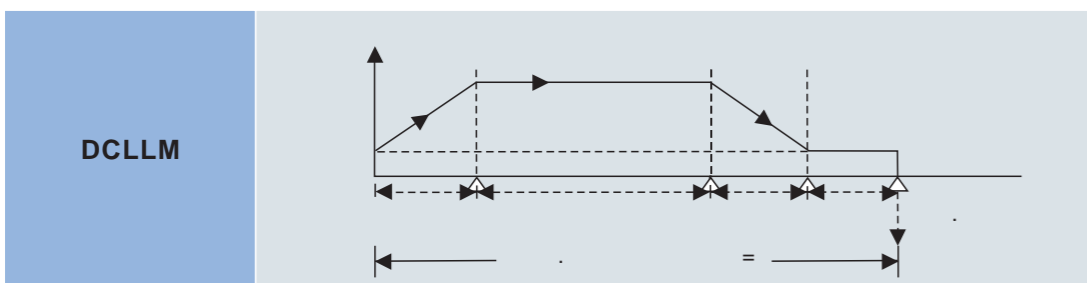
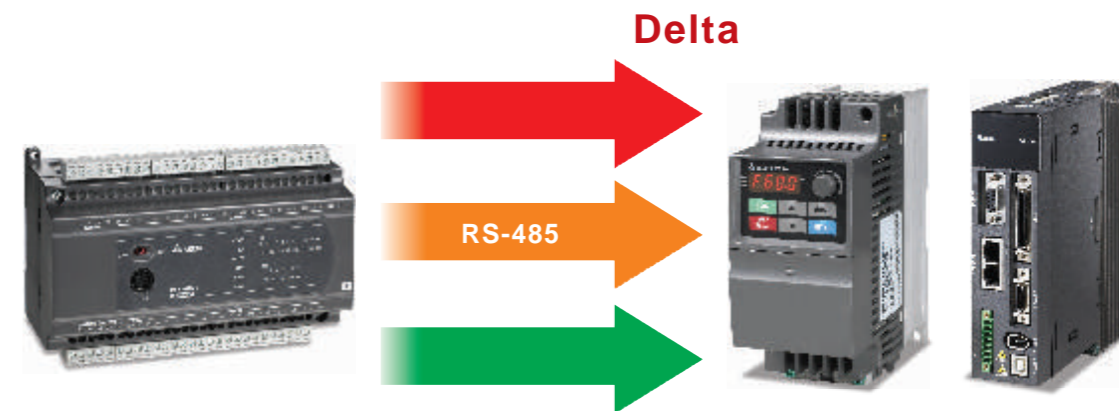
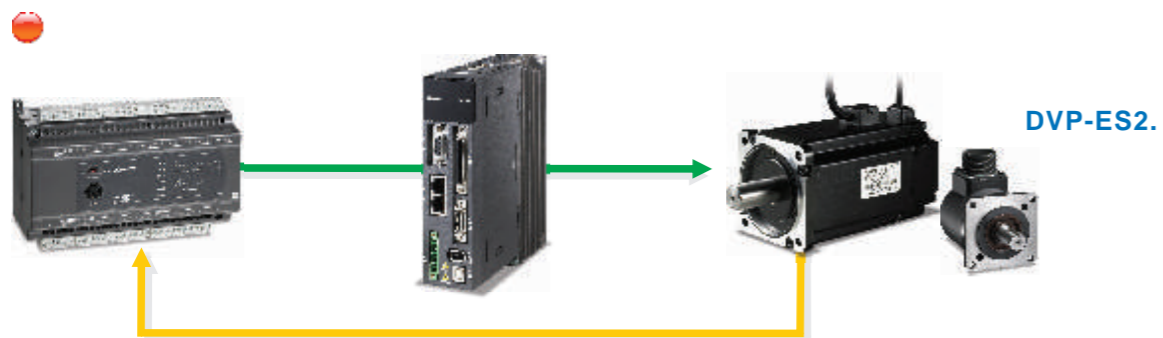

DVP-ES2 EX2
 RS-485
 DVP-ES2

	RS-485			Delta.	
	FWD	REV	STOP	RSTEF	RDST
	ASDRW				

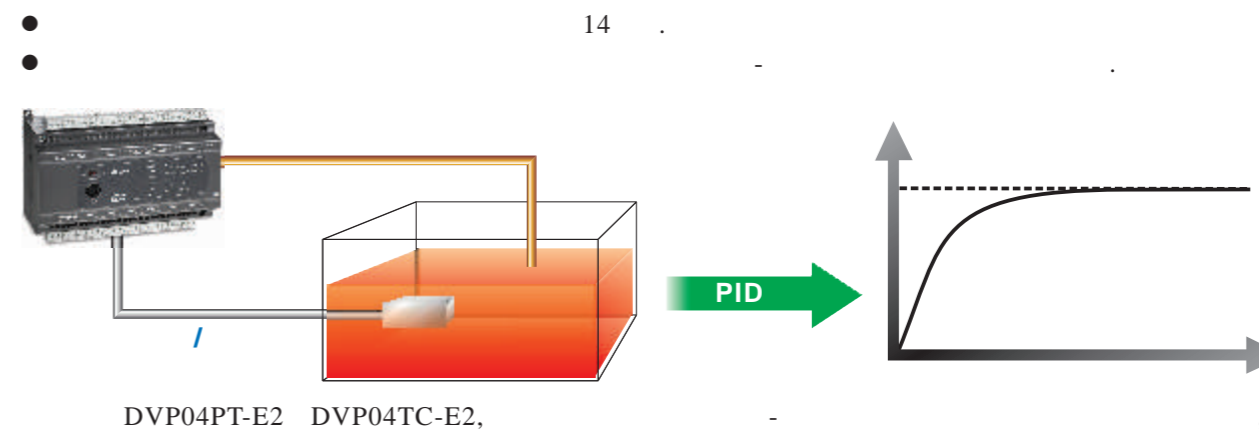

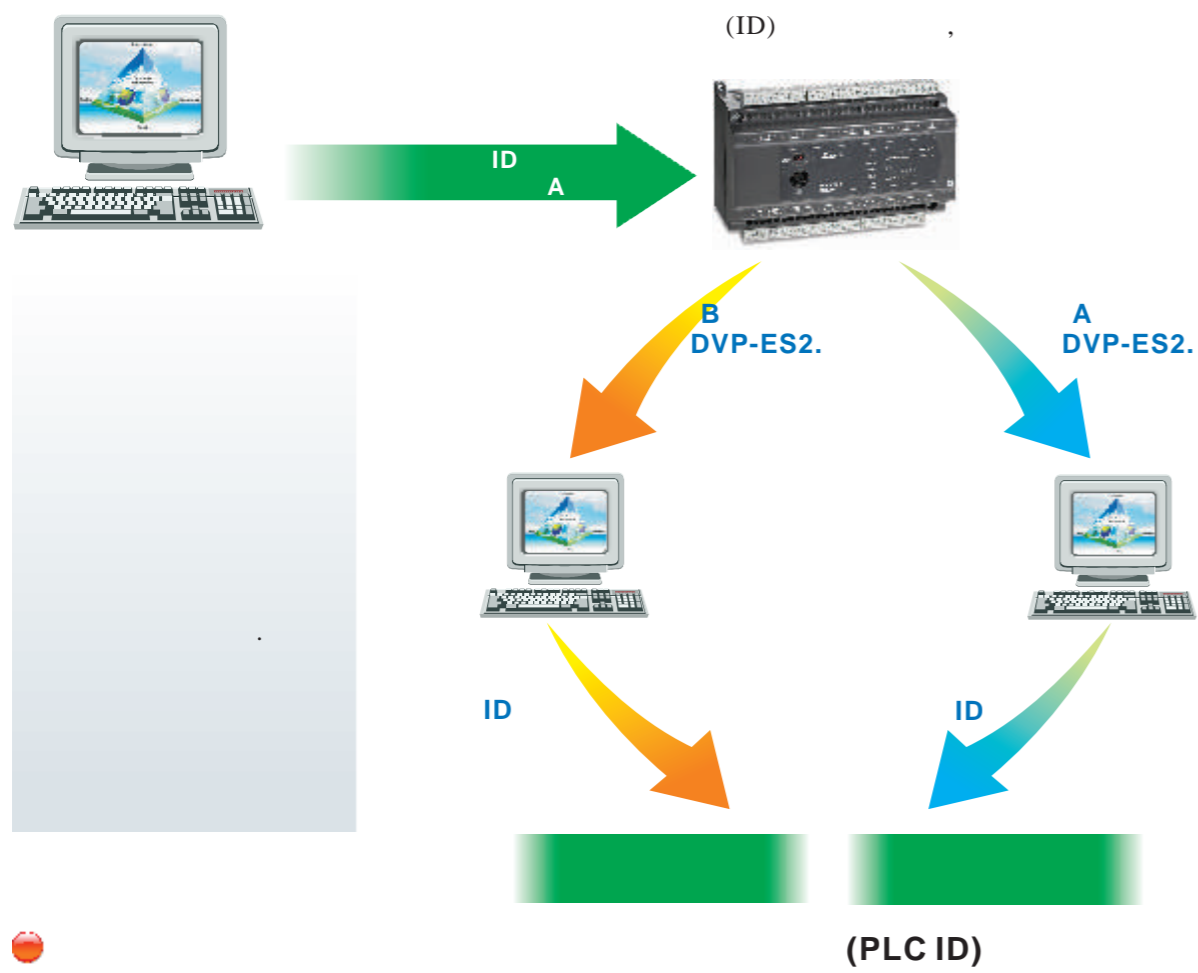

SPA GPS -

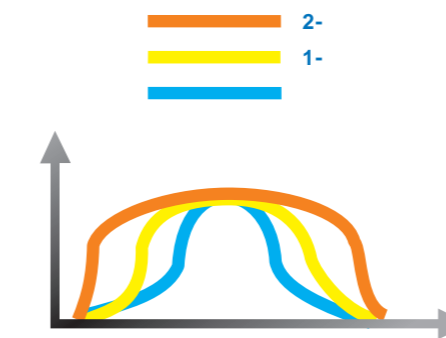

SPD -

2-

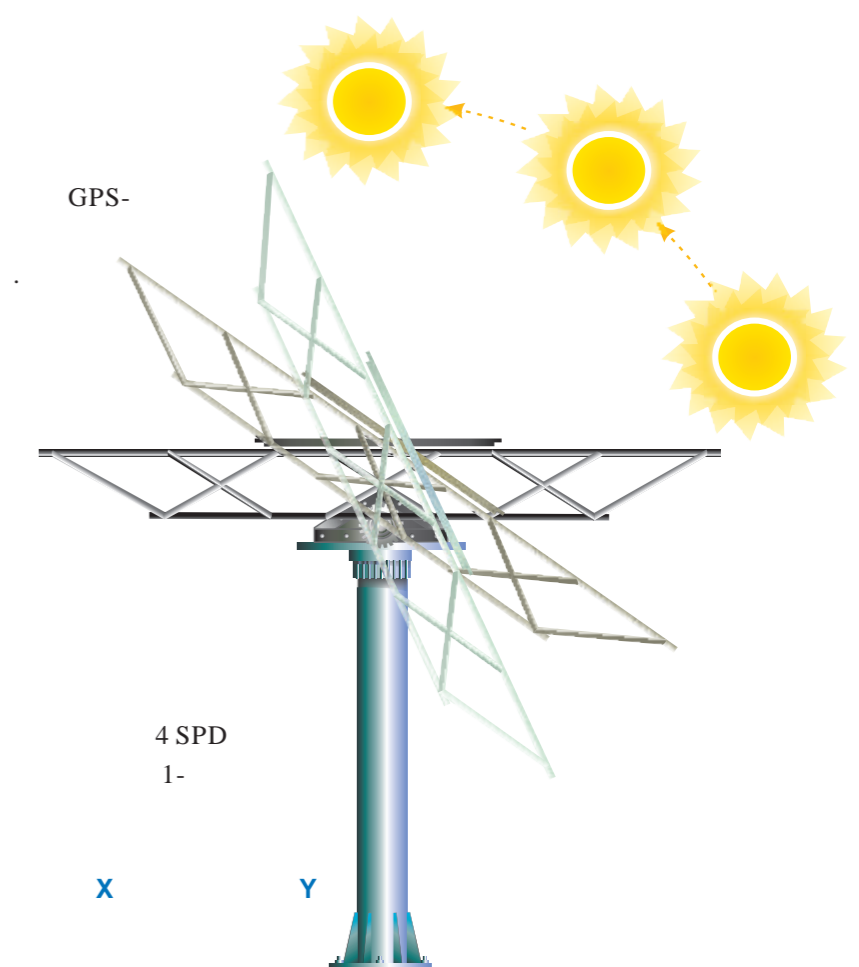

ID 4 ~ 8



FROM K0 K10 D0 K1

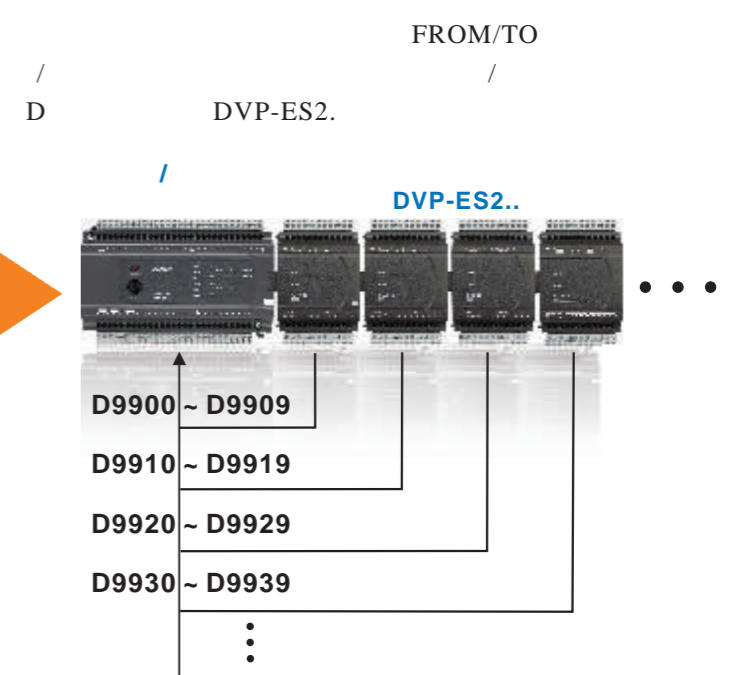

: ISPSoft

ISPSoft
ISPSoft
ISPSoft

LD, FBD

IEC61131-3.

ISPSoft

DVP.

(TASK)

The screenshot shows the ISPSoft software interface. On the left, a 'Task Manager' window lists various tasks and their assigned POU (Program Organization Unit) names. In the center, a ladder logic diagram is displayed with two networks. Network 1 contains a 'FUNCTION BLOCK INSTANCE' block. Network 2 contains an 'ADD3' function block. A 'Local Variables' table is visible at the bottom of the main window, listing variables like 'a1', 'a2', 'a3', and 'a4' with their respective types and initial values.

(POU),

POU

(TASK)

Каждый функциональный блок может использоваться многократно.

The screenshot shows the 'Create Function Block' dialog box in the ISPSoft software. The dialog has several fields and options: 'POU Name' (set to EN100), 'Protection' (set to None), 'Language' (set to Instruction List (IL)), and 'POU Comment'. There are also checkboxes for 'Use With Editor' and 'Separate Function Class (SPC)'. The background shows a portion of the ladder logic diagram.

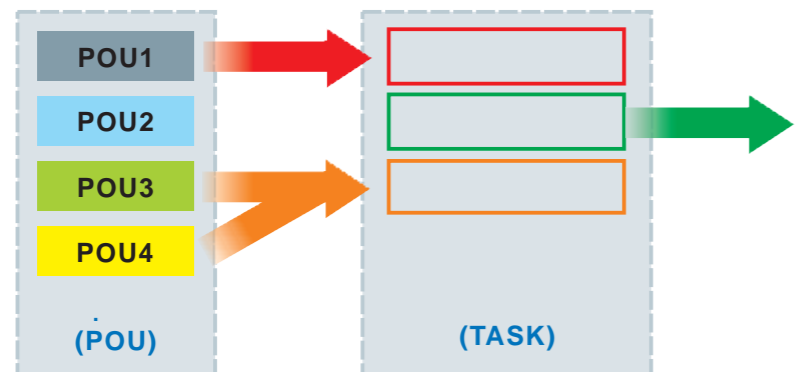
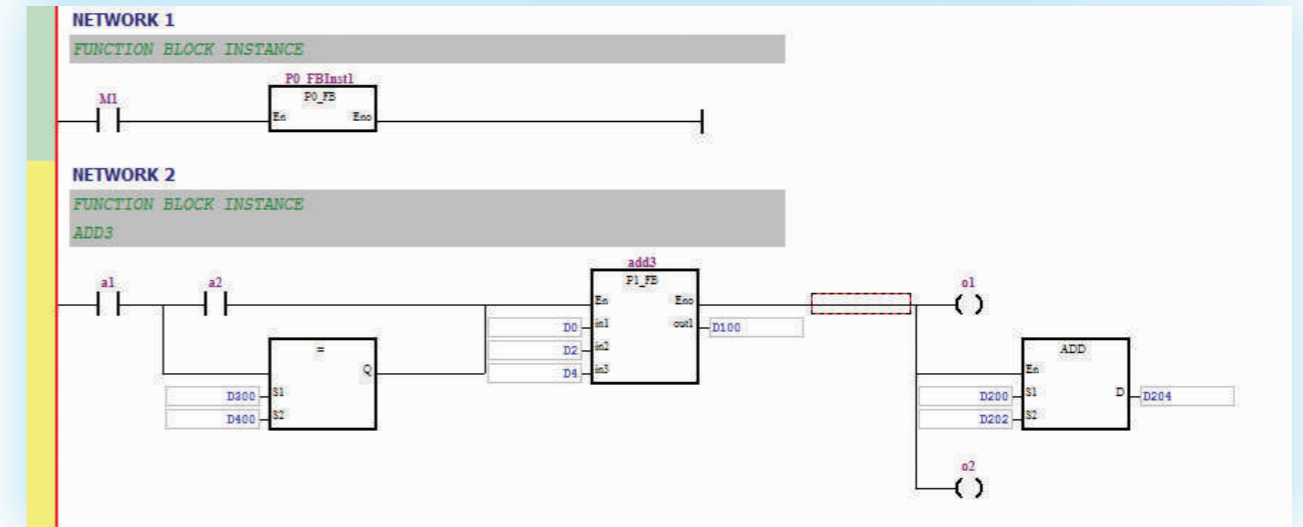

: ISPSoft

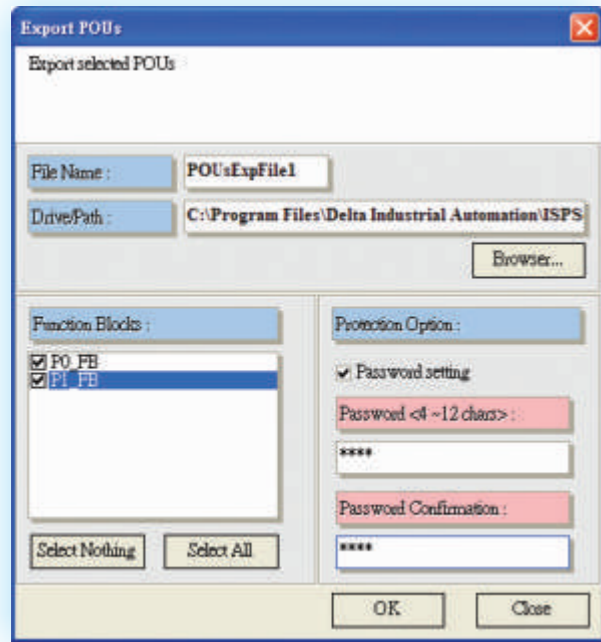

Global Variables

Variable	Address	Type	Initial Value	Comment
SI		BOOL	FALSE	
SI		BOOL	FALSE	
SI		BOOL	FALSE	
SI		BOOL	FALSE	
TSMP		WORD	0	
PI_FB		PI_FB		
PI1		PI_FB		
PI2		PI_FB		

POU.

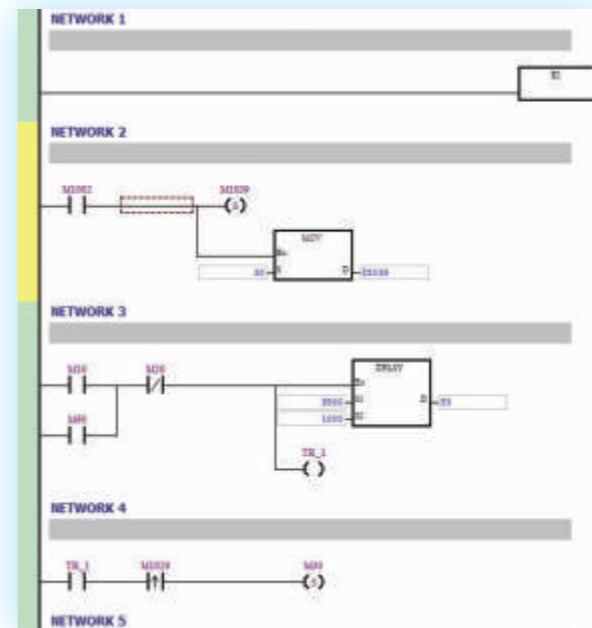

(network). ISPSoft

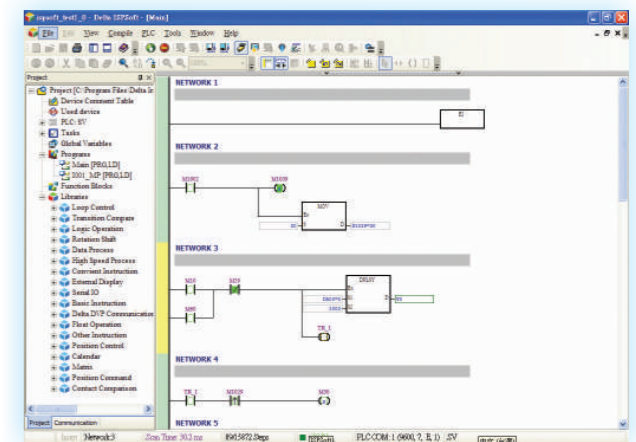

Global Variables

Variable	Address	Type	Initial Value	Comment
SI		BOOL	FALSE	
SI		BOOL	FALSE	
SI		BOOL	FALSE	
SI		BOOL	FALSE	
TSMP		WORD	0	
PI_FB		PI_FB		
PI1		PI_FB		
PI2		PI_FB		

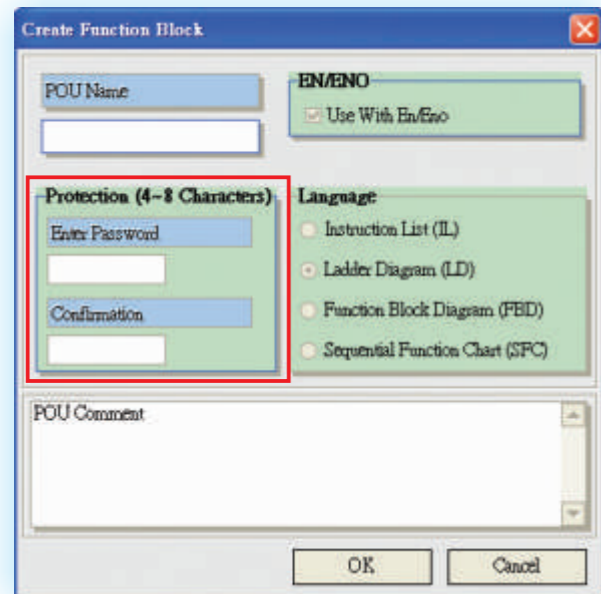

Global Variables table showing a list of variables and their addresses.

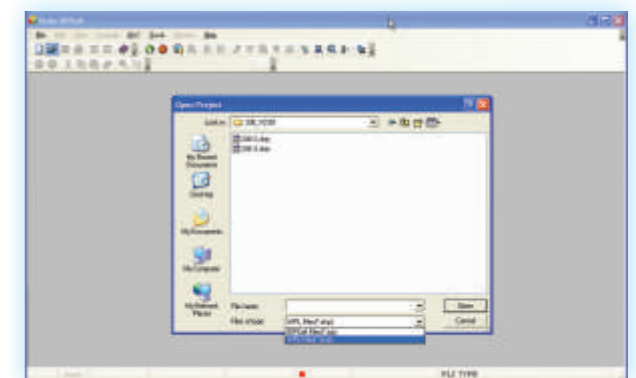
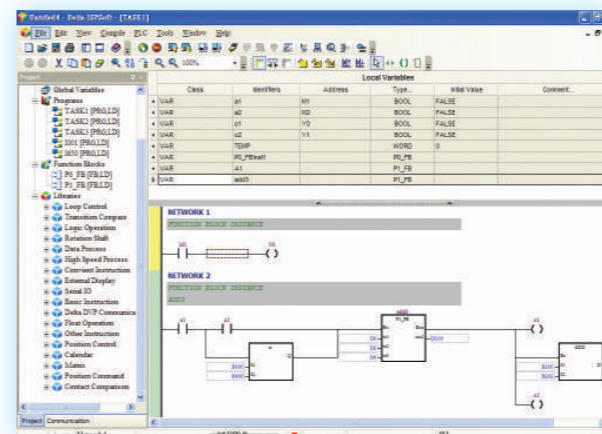

WPLSoft

WPLSoft
ISPSoft.

	DVP 16ES200□*1	DVP 20EX200□*1	DVP 24ES200□*1	DVP 32ES200□*1	DVP 40ES200□*1	DVP 60ES200□*1	
X	X0~X7 (8)	X0~X7 (8)	X0~X17 (16)	X0~X17 (16)	X0~X27 (24)	X0~X43 (36)	X20(X50)~X337*2
Y	Y0~Y7 (8)	Y0~Y5 (6)	Y0~Y7 (8)	Y0~Y17 (16)	Y0~Y17 (16)	Y0~Y27 (24)	Y20(Y30)~Y337*2
.	-	4 (12-)	-	-	-	-	-
.	-	2 (12-)	-	-	-	-	-

	DVP08XM 211N	DVP08XN 211□*1	DVP08XP 211□*1	DVP16XM 211N	DVP16XN 211□*1	DVP16XP 211□*1	DVP24XN 200□*1	DVP24XP 200□*1	DVP32XP 200□*1
X	X20~X27 (8)	-	X20~X23 (4)*3	X20~X37 (16)	-	X20~X27 (8)	-	X20~X37 (16)	X20~X37 (16)
Y	-	Y20~Y27 (8)	Y20~Y23 (4)*3	-	Y20~Y37 (16)	Y20~Y27 (8)	Y20~Y47 (24)	Y20~Y27 (8)	Y20~Y37 (16)

*1: R- ; T- (N); S- (P).
 *2: / / 8 8. DVP60ES2 8. X50 (Y30), DVP40ES2- X30 (Y20). - X20 (Y20).
 *3: / / 8 8.

	DVP 04AD-E2	DVP 04DA-E2	DVP 06XA-E2	DVP 02DA-E2	DVP 04TC-E2	DVP 04PT-E2
	AD1~4 (4CHx14-bit)	-	AD1~4 (4CHx14-bit)	-	CH1~4 (4CHx16-bit)	CH1~4 (4CHx16-bit)
	-	DA1~4 (4CHx14-bit)	DA1~2 (2CHx14-bit)	DA1~2 (2CHx14-bit)	-	-

X		X0~X377,	-	,256	256
Y		Y0~Y377,	-	,256	256
M		M0~M511, 512 M768~M999, 232 M2000~M2047, 48			4096
		M512~M767, 256 M2048~M4095, 2048			
		M1000~M1999, 1000			
T	100 (M1028=ON, T64~T126 =10)	T0~T126, 127 T128~T183, 56 T184~T199 T250~T255*6		,16	256 (TMR)

C	10 (M1038=ON, T200~T245 =1)	T200~T239, 40 T240~T245*6		256	(TMR)	
		T127, 1 T246~T249*, 4				
		16- C0~C111, 112 C112~C127, 16 C128~C199, 72		255	(CNT (DCNT))	
S	32-bit	C200~C223, 24 C224~C231, 8				
		C235~C244, 1- C245~C250, 1- C232~C234, C251~C254, 2- 7	.1 .2	10 6		
		S0~S9, 10 S10~S19, 10 (IST) S20~S127, 108 S128~S911, 784 S912~S1023, 112		1024	(SFC)	
D	(16)	T0~T255, 16- ,256				
		C0~C199, 16- C200~C254, 32- ,200 ,55				
		D0~D407, 408 D600~D999, 400 D3920~D9899, 5980		10000	E, F	
I		D408~D599, 192 D2000~D3919, 1,920				
		D1000~D1999, 1000 D9900~D9999, 100				
		E0~E7, F0~F7, 16				
N	CJ, CALL	N0~N7, 8				
		P0~P255, 256			CJ CALL	
		I00□(X0), I10□(X1), I20□(X2), I30□(X3), I40□(X4), I50□(X5), I60□(X6), I70□(X7), 8 (□=1, □=0,)				
K		I6□, I7□, (□□05~99), 2				
		I010□I020□I030□I040□I050□I060□I070□ I080□8				
		I140(COM1)□I150(COM2) I160(COM3) (*3)□3				
H		K-32768 ~ K32767 (16- K-2 147 483 648 ~ K2 147 483 647 (32-)				
		H0000 ~ HFFFF (16- H00000000 ~ HFFFFFFF (32-)				

*1: RS-232 ; COM2 COM3- RS-485
 *2: X Y
 *3: COM1- X ; COM2 COM3- Y
 *4: 16 . Y 256 . X
 *5: 10

M	M0~M511	M512~M767	M768~M999	M1000~M1999	M2000~M2047	M2048~M4095
---	---------	-----------	-----------	-------------	-------------	-------------

C	16-			32-		32-	
	C0~C111	C112~C127	C128~C199	C200~C223	C224~C231	C232~C254	

T	100		1		100		10		1		100	
	T0~T126	T127	T128~T183	T184	T200~T239	T240~T245	T246~T249	T250~T255				
	M1028=ON: T64~T126=10			T199	M1038=ON: T200~T245=1							

S	S0~S9		S10~S19		S20~S127		S128~S911		S912~S1023	
---	-------	--	---------	--	----------	--	-----------	--	------------	--

D	D0~D407		D408~D599		D600~D999		D1000~D1999		D2000~D3919		D3920~D9899		D9900~D9999	
---	---------	--	-----------	--	-----------	--	-------------	--	-------------	--	-------------	--	-------------	--

	OFF → ON	STOP → RUN	RUN → STOP	M1031=ON	M1032=ON	
			M1033= OFF, M1033=ON,			0
						0
M, D						

DVP-ES2

	DVP16ES200□	DVP24ES200□	DVP32ES200□	DVP40ES200□	DVP60ES200□	DVP20EX200□
	100 ~ 240V AC (-15% ~ 10%), 50/60 ±5%					
	DVP-ES2 70VAC.		95 ~ 100VAC 10			
	2A/250V AC					
	30VA					
	24VDC / 500					
	DC24V					
	1500V AC (Primary-secondary); 1500V AC (Primary-PE); 500V AC (Secondary-PE)					
	> 5	500VDC (/)				
						L, N,)

	DVP16ES200□	DVP24ES200□	DVP32ES200□	DVP40ES200□	DVP60ES200□	DVP20EX200□
	ESD: 8 kV					
	EFT: : 2kV, / : 1kV, / : 1kV					
	RS: 26MHz ~ 1GHz, 10V/m					
	: 0 °C~55 °C (), 50~95% (),					2
	: -25 °C~70 °C (), 5~95% ()					
	: IEC61131-2, IEC 68-2-6 (TEST Fc)/ IEC61131-2, IEC 68-2-27 (TEST Ea)					
	R: 377 T: 351	R: 414 T: 387	R: 489 T: 432	R: 554 T: 498	R: 696 T: 614	R: 462 T: 442

DVP-ES2 MPU

	DC (PNP NPN)		
	24VDC, 5		
Input No.	X0,X2	X1,X3~X7	X10~X17,X20
Off -> On	> 15VDC		
On -> Off	< 5VDC		
Off -> On	2.5	20	10
On -> Off	5	50	10
	100	10	50
X0 ~ X7	(0 ~ 20) D1020 (: 10)		
	4.7K		

DVP-ES2 MPU

	(R)	(T)		
		Y0 Y2	Y1 Y3	Y4~Y17, Y20~
	2A/1 (5A/COM)	0.5A/1 (4A/COM)		
	< 250VAC, 30VDC	5 ~ 30VDC		
	75VA (.) 90W (.)	12W/1 (24VDC)		
	Off -> On	.10	2	20
	On -> Off		3	30
		100	10	1

DVP-EX2

	(A/D)		(D/A)	
	±10	±20	±10	0~20
	-2000 ~ +2000	-2000 ~ +2000	-2000 ~ +2000	0 ~ +4000
	12- (5.0 =20 /4000)	12- (10.0 =40 /4000)	12- (5.0 =20 /4000)	12- (5.0 =20 /4000)
	>1 M	250		
			0.5	
			>0.5	<500
	: 1%		: 1%	
	2 (D1118) ^{#1}		20 +10V	
	±15	±32	2 ^{#2}	
	2 16- , 12			
	(D1062) ^{#3}			

#1: D1118,
#2: = "1", 2
#3: = "1", 2

		24VDC
DVP16ES200R/T	30	500 (12)
DVP24ES200R/T		
DVP32ES200R/T		
DVP40ES200R/T		
DVP60ES200R/T		
DVP20EX200R/T	20	100 (2.4)
DVP24XP200R/T		
DVP32XP200R/T	R:25 T: 20	
DVP08XM211N	1.2	
DVP08XP211R/T	R: 1.2 T: 1	
DVP08XN211R/T	R: 1.2 T: 0.5	
DVP16XM211N	2.4	
DVP16XP211R/T	R: 2.4 T: 1.6W	
DVP16XN211R/T	R: 2.4 T: 1	
DVP04AD-E2	1	
DVP02DA-E2	1.5	
DVP04DA-E2	3	
DVP06XA-E2	2.5	
DVP04PT-E2	1.5	
DVP04TC-E2	1.2	

32ES200R + 08XP211R + 16XP211R + 16XN211R,

ES2
12 , . .

(1.2+2.4+2.4) = 6 .

DVP16ES200R/T

L	N	Ⓞ	NC	+24V	24G	S/S	X0	X1	X2	X3	X4	X5	X6	X7
D+	D-	SG	D+	D-	C0	Y0	Y1	Y2	Y3	C1	Y4	Y5	Y6	Y7

L	N	Ⓞ	NC	+24V	24G	S/S	X0	X1	X2	X3	X4	X5	X6	X7
D+	D-	SG	D+	D-	UP	ZP	Y0	Y1	Y2	Y3	Y4	Y5	Y6	Y7

DVP24ES200R/T

L	N	Ⓞ	NC	S/S	X0	X1	X2	X3	X4	X5	X6	X7	X10	X11	X12	X13	X14	X15	X16	X17
D+	D-	SG	D+	D-	+24V	24G	C0	Y0	Y1	Y2	Y3	C1	Y4	Y5	Y6	Y7				

L	N	Ⓞ	NC	S/S	X0	X1	X2	X3	X4	X5	X6	X7	X10	X11	X12	X13	X14	X15	X16	X17
D+	D-	SG	D+	D-	+24V	24G	UP	ZP	Y0	Y1	Y2	Y3	Y4	Y5	Y6	Y7				

DVP32ES200R/T

L	N	Ⓞ	NC	+24V	24G	S/S	X0	X1	X2	X3	X4	X5	X6	X7	X10	X11	X12	X13	X14	X15	X16	X17		
D+	D-	SG	D+	D-	C0	Y0	Y1	Y2	Y3	C1	Y4	Y5	Y6	Y7	C2	Y10	Y11	Y12	Y13	C3	Y14	Y15	Y16	Y17

L	N	Ⓞ	NC	+24V	24G	S/S	X0	X1	X2	X3	X4	X5	X6	X7	X10	X11	X12	X13	X14	X15	X16	X17		
D+	D-	SG	D+	D-	UP0	ZP0	Y0	Y1	Y2	Y3	Y4	Y5	Y6	Y7	UP1	ZP1	Y10	Y11	Y12	Y13	Y14	Y15	Y16	Y17

DVP40ES200R/T

L	N	Ⓞ	NC	S/S	X0	X1	X2	X3	X4	X5	X6	X7	X10	X11	X12	X13	X14	X15	X16	X17	X20	X21	X22	X23	X24	X25	X26	X27
D+	D-	SG	D+	D-	+24V	24G	C0	Y0	Y1	Y2	Y3	C1	Y4	Y5	Y6	Y7	C2	Y10	Y11	Y12	Y13	C3	Y14	Y15	Y16	Y17		

L	N	Ⓞ	NC	S/S	X0	X1	X2	X3	X4	X5	X6	X7	X10	X11	X12	X13	X14	X15	X16	X17	X20	X21	X22	X23	X24	X25	X26	X27
D+	D-	SG	D+	D-	+24V	24G	UP0	ZP0	Y0	Y1	Y2	Y3	Y4	Y5	Y6	Y7	UP1	ZP1	Y10	Y11	Y12	Y13	Y14	Y15	Y16	Y17		

DVP60ES200R/T

L	N	Ⓞ	NC	S/S	X0	X1	X2	X3	X4	X5	X6	X7	X10	X11	X12	X13	X14	X15	X16	X17	X20
D+	D-	SG	D+	D-	+24V	24G	C0	Y0	Y1	Y2	Y3	C1	Y4	Y5	Y6	Y7	C2	Y10	Y11	Y12	Y13

X21	X22	X23	X24	X25	X26	X27	X30	X31	X32	X33	X34	X35	X36	X37	X40	X41	X42	X43
C3	Y14	Y15	Y16	Y17	C4	Y20	Y21	Y22	Y23	C5	Y24	Y25	Y26	Y27				

L	N	Ⓞ	NC	S/S	X0	X1	X2	X3	X4	X5	X6	X7	X10	X11	X12	X13	X14	X15	X16	X17	X20
D+	D-	SG	D+	D-	+24V	24G	UP0	ZP0	Y0	Y1	Y2	Y3	Y4	Y5	Y6	Y7	UP1	ZP1	Y10	Y11	Y12

X21	X22	X23	X24	X25	X26	X27	X30	X31	X32	X33	X34	X35	X36	X37	X40	X41	X42	X43
Y13	Y14	Y15	Y16	Y17	UP2	ZP2	Y20	Y21	Y22	Y23	Y24	Y25	Y26	Y27				

DVP20EX200R/T

L	N	Ⓞ	NC	S/S	X0	X1	X2	X3	X4	X5	X6	X7	FE	V0+	I0+	V10-	V1+	I1+	V11-	V2+	I2+	V12-		
D+	D-	SG	D+	D-	+24V	24G	C0	Y0	Y1	Y2	Y3	C1	Y4	Y5	FE	V3+	I3+	V13-	V00	I00	AG	V01	I01	AG

L	N	Ⓞ	NC	S/S	X0	X1	X2	X3	X4	X5	X6	X7	FE	V0+	I0+	V10-	V1+	I1+	V11-	V2+	I2+	V12-		
D+	D-	SG	D+	D-	+24V	24G	UP	ZP	Y0	Y1	Y2	Y3	Y4	Y5	FE	V3+	I3+	V13-	V00	I00	AG	V01	I01	AG

DVP-ES2/EX2

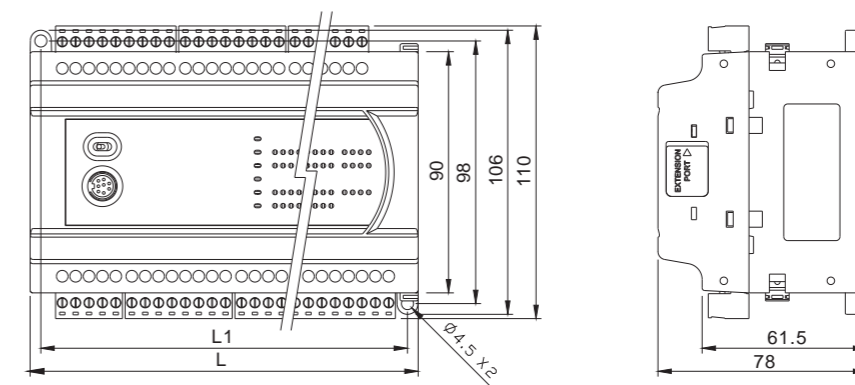

	16ES200R/T	24ES200R/T	32ES200R/T	40ES200R/T	60ES200R/T	20EX200R/T
L	105	125	145	165	225	145
L1	97	117	137	157	217	137

DVP-ES2/EX2

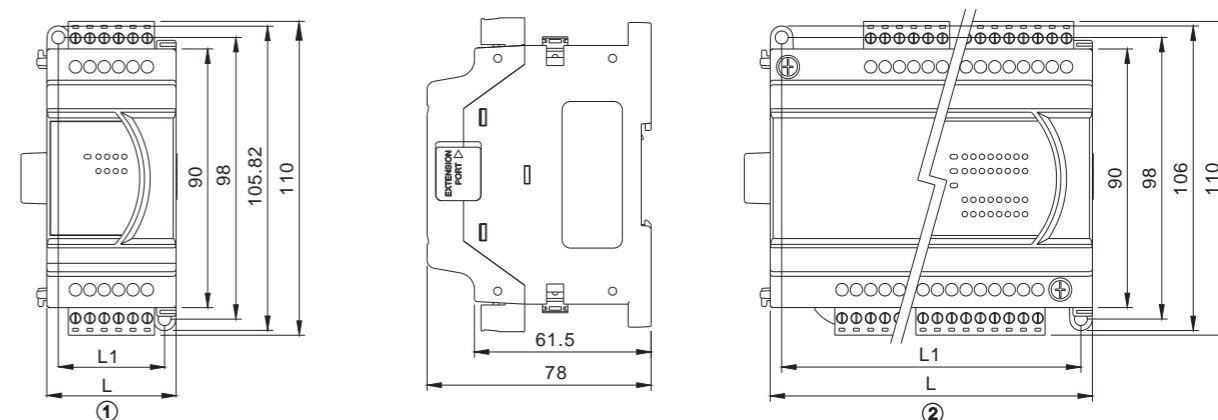

	08XM2 11N	08XP2 11R/T	08XN2 11R/T	16XM2 11N	16XP2 11R/T	16XN2 11R/T	24XP2 00R/T	24XN2 00R/T	32XP2 00R/T
L		45			70			145	
L1		37			62			137	
		①			②			②	

	04AD-E2	02DA-E2 04DA-E2	06XA-E2	04PT-E2	04TC-E2
L			70		
L1			62		
			②		

DVP-ES2	DVP16ES200R	: 100~240VAC : 272 : 16k : 10k : 2 100 ; 6 10 : 2 100 ; 2 10 () COM- : 1 RS-232 2 RS-485; Modbus ASCII/RTU; Master Slave		8	8		
	DVP16ES200T			8	8		
	DVP24ES200R			16	8		
	DVP24ES200T			16	8		
	DVP32ES200R			16	16		
	DVP32ES200T			16	16		
	DVP40ES200R			24	16		
	DVP40ES200T			24	16		
	DVP60ES200R			36	24		
	DVP60ES200T			36	24		
DVP-EX2	DVP20EX200R	: 100~240VAC : 272 : 16k : 10k : 2 100 ; 6 10 : 2 100 ; 2 10 () COM- : 1 RS-232 2 RS-485; Modbus ASCII/RTU; Master Slave / : 12- 4AD/2DA		8	6		
	DVP20EX200T			4	2		
	DVP20EX200T			8	6		
				4	2		

16- : 0.35 ~ 1
32- (MOV): 3.4
32- (DMUL): 11.4 (DEMUL): 10.3
/ (AC)

DVP-ES2/EX2	DVP24XN200R	: 100~240VAC		-	24		
	DVP24XN200T			-	24		
	DVP24XP200R			16	8		
	DVP24XP200T			16	8		
	DVP32XP200R			16	16		
	DVP32XP200T			16	16		

(24VDC)

DVP-ES2/EX2	DVP08XM211N	-	8	-	-		
	DVP08XN211R	-	-	8	-		
	DVP08XN211T	-	-	8	-		
	DVP08XP211R	-	4	4	-		
	DVP08XP211T	-	4	4	-		
	DVP16XM211N	-	16	-	-		
	DVP16XN211R	-	-	16	-		
	DVP16XN211T	-	-	16	-		
	DVP16XP211R	-	8	8	-		
	DVP16XP211T	-	8	8	-		
DVP-ES2/EX2	DVP04AD-E2	■ 4 (+20mA, 0~20mA, 4~20mA) : 14-bit (-32000~+32000)	(±10V, ±5V)/	-	-		
	DVP04DA-E2	■ 4 (0~20mA, 4~20mA) : 14- (-32000~+32000)/(0~+32000)	(-10V~+10V)/	-	-		
	DVP02DA-E2	■ 2 (0~+20mA, 4~20mA) : 14- (-32000~+32000)/(0~+32000)	(-10V~+10V)/	-	-		
	DVP06XA-E2	■ 4 (±20mA, 0~20mA, 4~20mA) : 14- (-32000~+32000) ■ 2 (0~20mA, 4~20mA) : 14- (-32000~+32000)/(0~+32000)	(±10V, ±5V)/ (-10V~+10V)/	-	-		
DVP-ES2/EX2	DVP04PT-E2	■ 4 Pt1000, Ni100, Ni1000) /0~300 : 16	(Pt100,	-	-		
	DVP04TC-E2	■ 4 /-80mV~+80mV : 16	(J, K, R, S, T, E, N)	-	-		