



### **IABU Headquarters**

**Delta Electronics, Inc.**  
Taoyuan1

31-1, Xingbang Road, Guishan Industrial Zone,  
Taoyuan County 33370, Taiwan, R.O.C.  
TEL: 886-3-362-6301 / FAX: 886-3-362-7267

### **Asia**

**Delta Electronics (Jiang Su) Ltd.**  
Wujiang Plant3

1688 Jiangxing East Road,  
Wujiang Economy Development Zone,  
Wujiang City, Jiang Su Province,  
People's Republic of China (Post code: 215200)  
TEL: 86-512-6340-3008 / FAX: 86-512-6340-7290

**Delta Greentech (China) Co., Ltd.**

238 Min-Xia Road, Cao-Lu Industry Zone, Pudong, Shanghai,  
People's Republic of China  
Post code : 201209  
TEL: 021-58635678 / FAX: 021-58630003

**Delta Electronics (Japan), Inc.**

**Tokyo Office**

Delta Shibadaimon Building, 2-1-14  
Shibadaimon, Minato-Ku, Tokyo, 105-0012,  
Japan  
TEL: 81-3-5733-1111 / FAX: 81-3-5733-1211

**Delta Electronics (Korea), Inc.**

234-9, Duck Soo Building 7F, Nonhyun-Dong,  
Kangnam-Gu, Seoul, Korea 135-010  
TEL: 82-2-515-5305 / FAX: 82-2-515-5302

**Delta Electronics (Singapore) Pte. Ltd.**

8 Kaki Bukit Road 2, #04-18 Ruby Warehouse Complex,  
Singapore 417841  
TEL: 65-6747-5155 / FAX: 65-6744-9228

**Delta Power Solutions (India) Pte. Ltd.**

Plot No. 28, Sector-34, EHTP  
Gurgaon-122001 Haryana, India  
TEL: 91-124-416-9040 / FAX: 91-124-403-6045

### **America**

**Delta Products Corporation (USA)**

**Raleigh Office**

P.O. Box 12173, 5101 Davis Drive,  
Research Triangle Park, NC 27709, U.S.A.  
TEL: 1-919-767-3813 / FAX: 1-919-767-3969

**Delta Products Corporation (Brazil)**

**Sao Paulo Office**

Rua Itapeva, Nº 26, 3º andar, Bela vista  
ZIP: 01332-000 - São Paulo - SP - Brasil  
TEL : 55-11-3568-3875 / FAX : 55-11-3568-3865

### **Europe**

**Deltronics (The Netherlands) B.V.**

**Eindhoven Office**

De Witbogt 15, 5652 AG Eindhoven, The Netherlands  
TEL: 31-40-2592850 / FAX: 31-40-2592851

\*We reserve the right to change the information in this catalogue without prior notice



## Industrial Fieldbus Solutions



# Great Leap Forward in Industrial Network!

In answering the demand for large quantity and highly efficient communication, a variety of industrial networks have gradually replaced the conventional serial communication in terms of their higher transmission speed and better transmission quality in remote applications.

## Flexible Application

All kinds of industrial networks construct multi-layer networks, offering various and flexible applications.



## Rapid Transmission

The Ethernet 10/100Mbps network solution is applicable in large quantity of data transmission and remote monitoring. The real-time data transmission offered by CANopen/DeviceNet solution is applicable in communication control system.



## Easy Software Configuration

The exclusively designed software, graphical network nodes and tabulated data exchange make the configuration easier than ever.

## Strong Noise Resistance

Fieldbus system: The cables with isolation for DeviceNet and CANopen are able to combat all kinds of on-site noise interference.





**Flexible & Highly-Efficient Network Environment!**

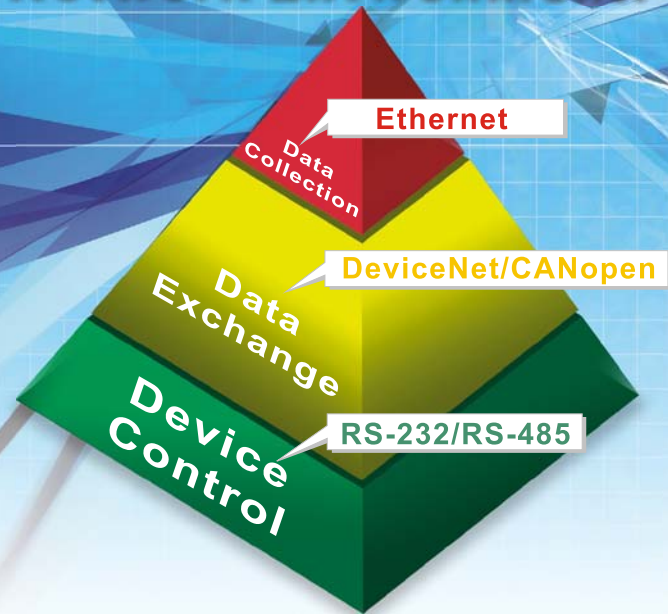

Delta's industrial network products offer the users stable, fast and accurate solutions.

**Ethernet**

All of Delta's Ethernet communication products provide 10/100Mbps transmission speed, web browser, all kinds of software tools and highly efficient on-site monitoring functions for remote users.

**DeviceNet**

All of Delta's DeviceNet communication products offer maximum 500kbps transmission speed, PLC master station, slave station, remote I/O module and converter. They can all be integrated through DeviceNet, realizing standard and wiring-saving applications in complicated industrial environment of high interference.

**RS-485**

All of Delta's industrial automation products are built-in with RS-485 communication interface, support Modbus communication and can be easily integrated with devices of other brands.

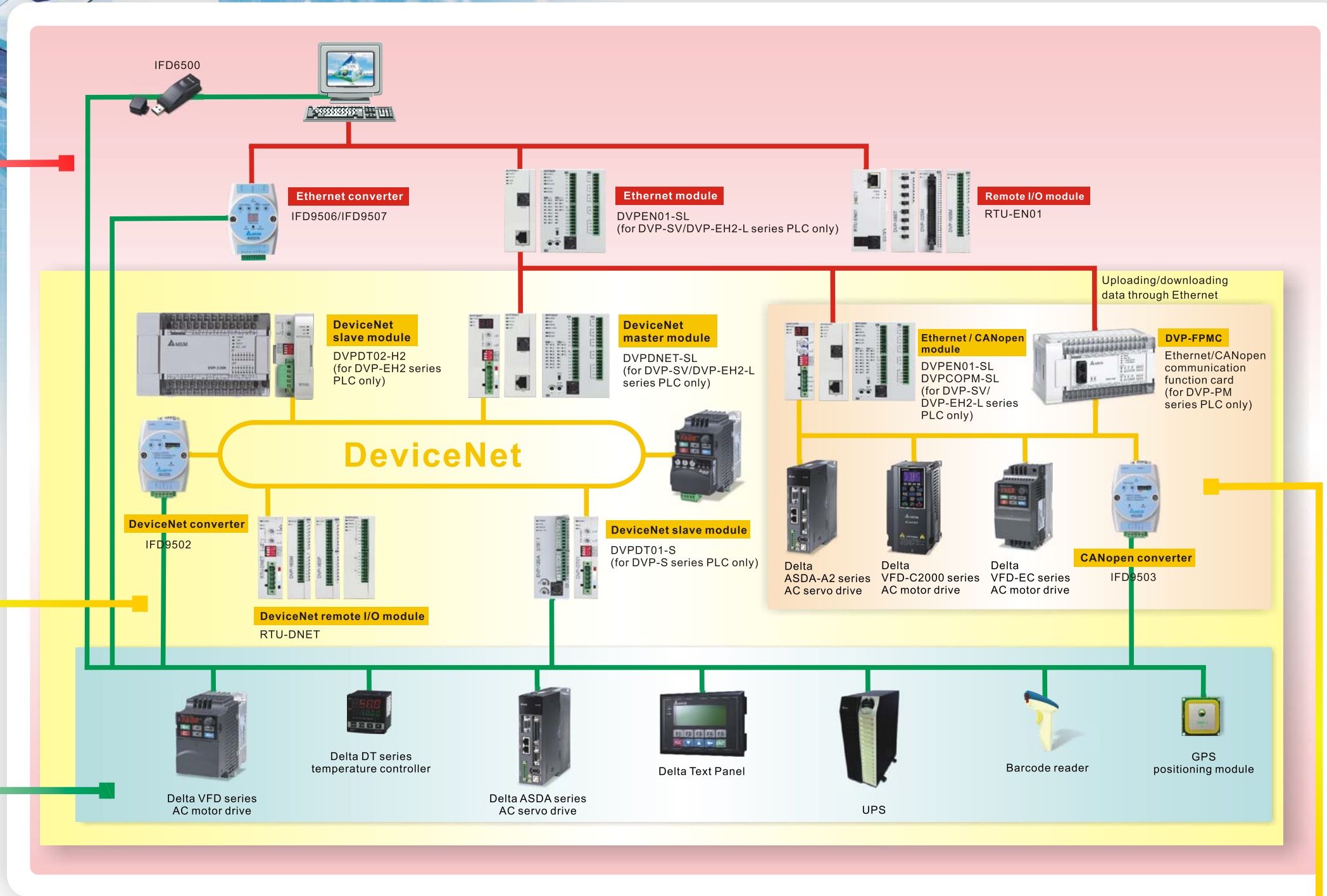

**Remote I/O**

Delta's industrial network products specific for remote I/O application support DeviceNet, Ethernet, PROFIBUS and RS-485, satisfying all kinds of users' demands in terms of cost and efficiency.

**Gateway**

Delta currently offers the following industrial network converters: RS-485 to RS-232, USB to RS-485, DeviceNet to RS-485/232, CANopen to RS-485/232, Ethernet (Modbus TCP, EtherNet/IP) to RS-232/485.

**CANopen**

All of Delta's CANopen communication products offer maximum 1Mbps communication speed. For the motion control solution, there are CANopen master stations with 301 and 402 protocols and ASDA-A2 series AC servo drives built-in with CANopen, which are able to easily realize complicated and multi-axis high-speed motion control.





## Ethernet: The Boundaryless Application

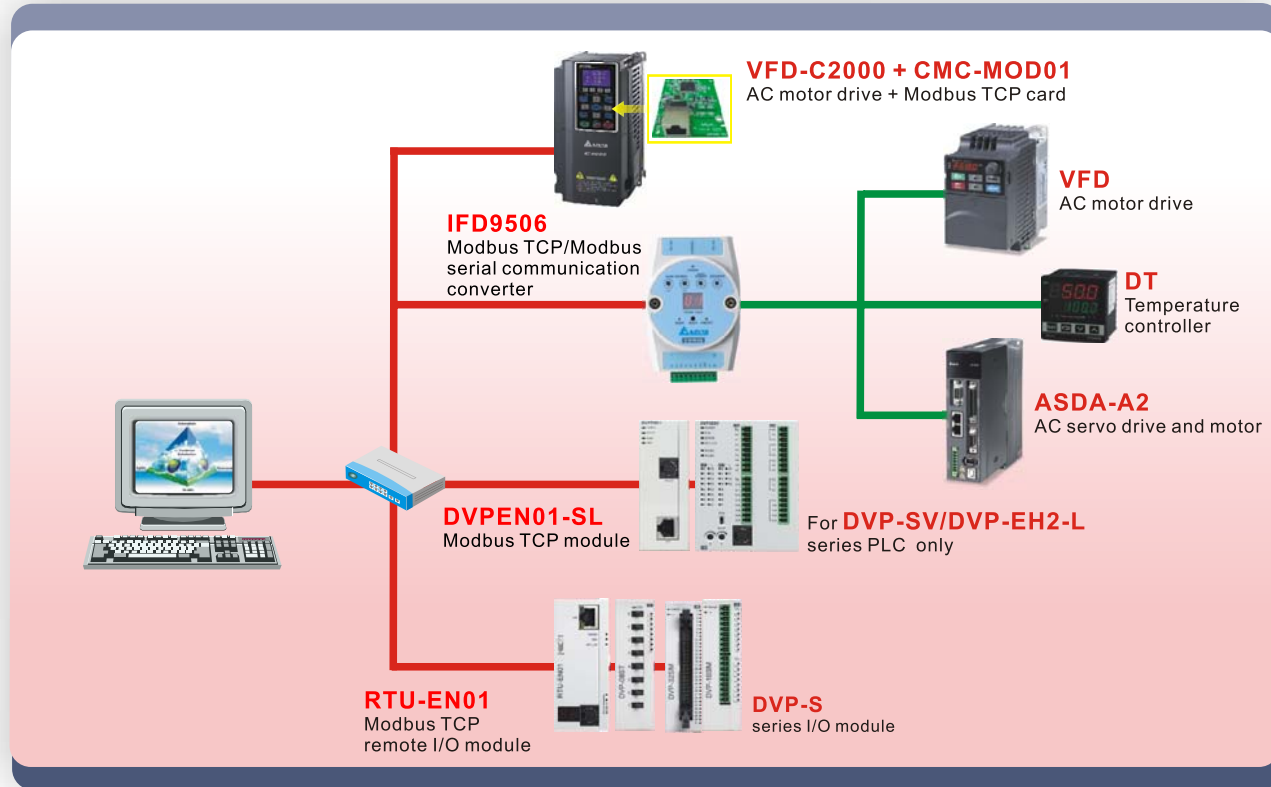

Delta's industrial automation products offer a complete Ethernet solution by conducting remote maintenance, modification and monitoring through Internet/ Intranet. A variety of software is handy for the user to connect to SCADA or interface developed by VB/VC.

### Virtual COM

The virtual COM function in Delta's IFD9506, IFD9507 and RTU-EN01 allows the user to simulate the Ethernet communication port into many serial ports by PC to increase the flexibility of the use of device.



### TCP Connection

Maximum 16 host devices are able to conduct monitoring through IFD9506 or IFD9507.

### Webpage Monitoring

The user can easily connect to RTU-EN01, IFD9506 or IFD9507 to monitor the remote equipment by using web browser anyplace at any time.

### Monitoring Function

The monitoring function in IFD9506 and IFD9507 read the data in the slave device non-stop and save them to the internal register. When the host PC or PLC are to read the content in the slave device, the registers in IFD9506/IFD9507 will respond directly, which enhances the efficiency of data response.

### E-Mail Alarm

All of Delta's Ethernet communication modules are designed with e-mail alarm function. The alarm from on-site equipment can be sent to designated mailboxes by e-mail.

### Smart PLC

RTU-EN01 is built-in with smart PLC function, including timer, counter and real-time clock. It also allows the user to customize their own simple action for logical and sequential control over I/O points, which saves the resource and work load of the PLC.

## DeviceNet: Best Communication Tool in Manufacturing Site

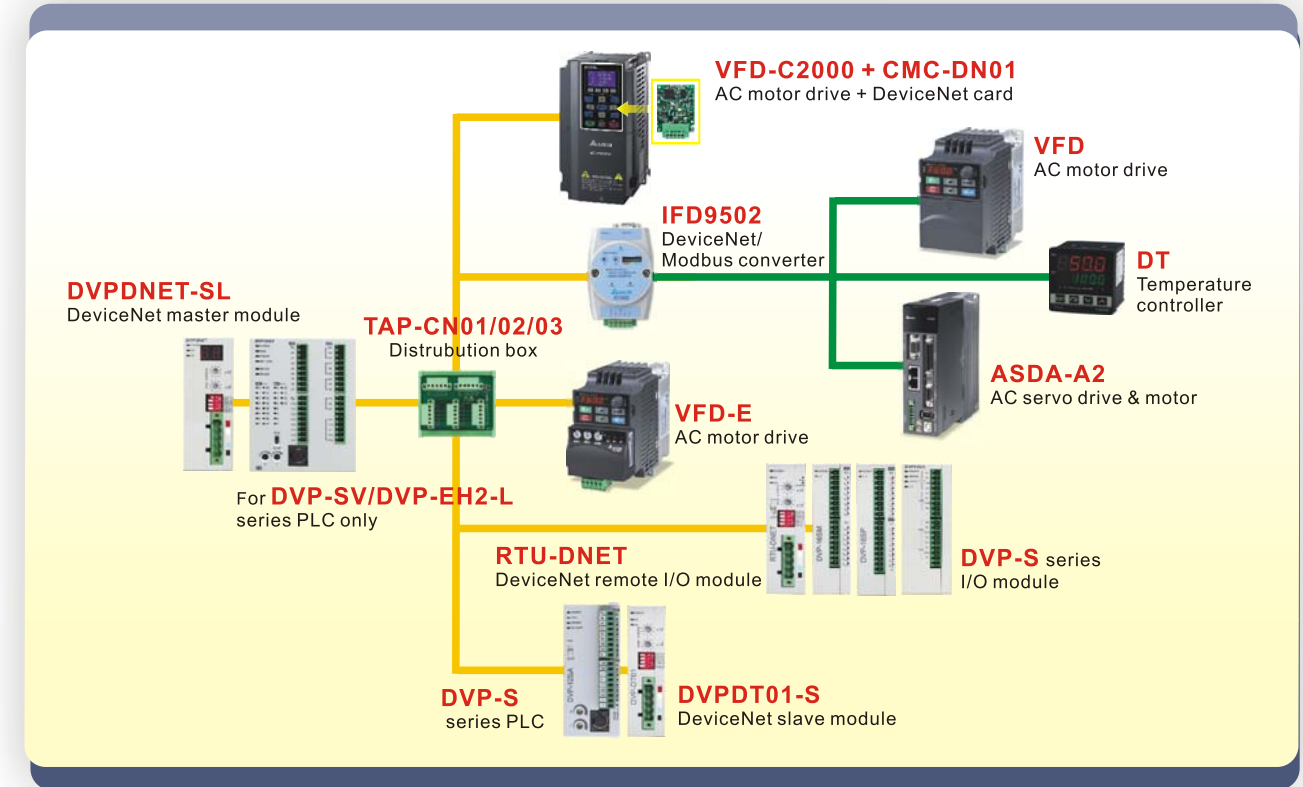

Delta's DeviceNet communication products respond fast and are able to combat interference, applicable in all kinds of harsh manufacturing environment. They also support DeviceNet Builder, the software for the user to fast plan the FA network.

### Automatic Off-line Diagnosis

DeviceNet can automatically conduct off-line diagnosis and send the off-line situation to the master station to save the time for checking the wiring.

### Auto Connection Recovery

After the off-line problem is solved, DeviceNet will automatically recover the connection without resetting the software or going through extra procedures.

### Interference Resistance

DeviceNet is excellent in combating interference, so is suitable for manufacturing site of big interference.

### Compatible Software

The software for Delta's DeviceNet communication products is built-in with EDS files for all the products and allows creating all kinds of devices by importing EDS files.

### Cross-Product Integration

Apart from PLC modules, Delta also offers AC motor drive, remote I/O module, branch cable distribution box and connection cable for the user to integrate all the products in use by DeviceNet.

### Topological Network Structure

The user can customize many different types of topology for more flexible use of the network structure.

### Simple Wiring



The DeviceNet terminals make the on-site wiring easier. The enclosed fastening screws stabilize the wiring.





## CANopen: Perfect Solution for Motion Control

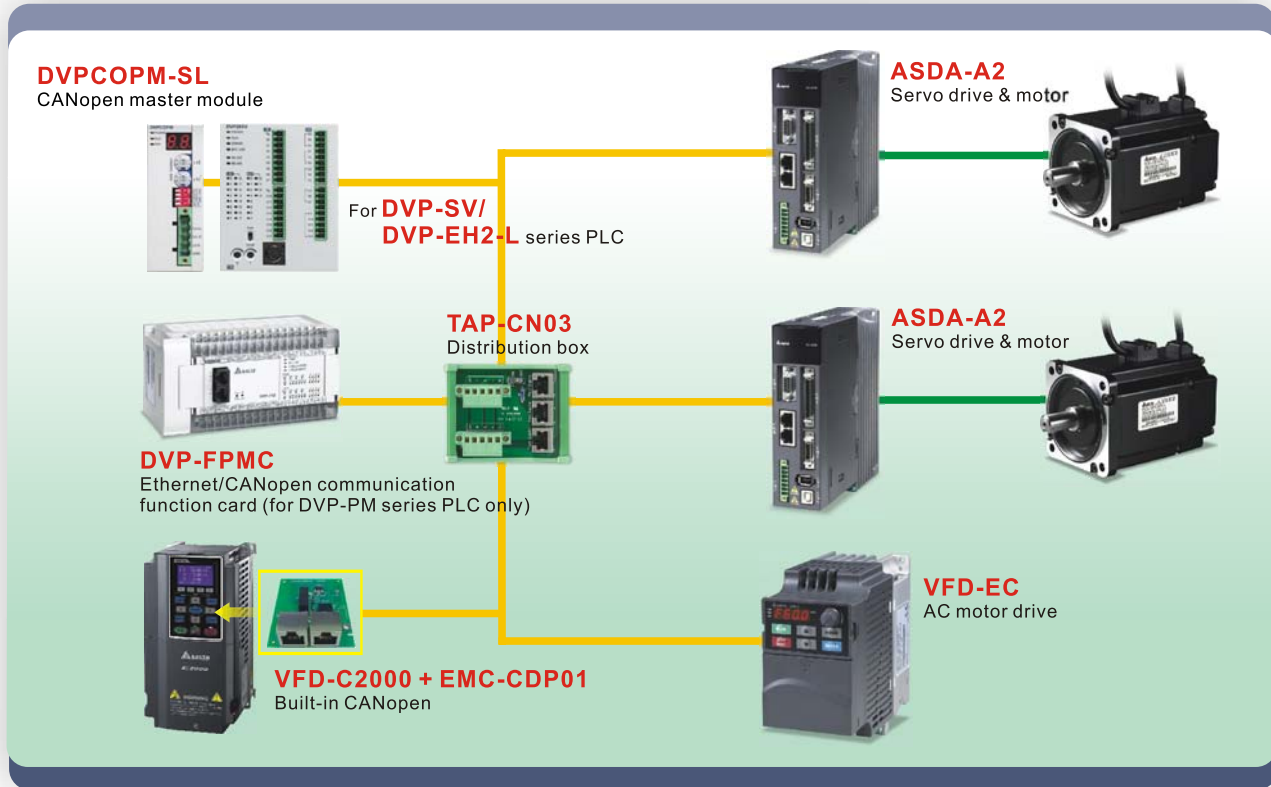

Delta's CANopen related products feature fast response speed and are able to work with ASDA-A2 series AC servo drive and DSP402 motion control communication protocol for communication. In terms of motion control, there is a breakthrough in the pulse output frequency and control axes for PLC MPU and the achievement in single wiring to allow the servo drive to exert its function to fullness.

### Sophisticated Motion Control

The CANopen communication in DVP-PM series PLC not only supports standard CiA DSP402 communication protocol but also is built-in with E-CAM and electronic gear, devices for sophisticated motion control.

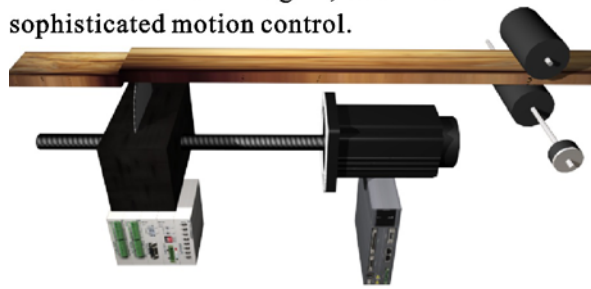

### Real-Time Communication

CANopen improves the procedure of Modbus communication, so the next command can be sent out without having to wait for the slave station to complete the processing of data, which enhances the communication efficiency and realizes the accuracy required for motion control.

### Function Block

Delta's CANopen software, CANopen Builder, offers function blocks for the user to organize complicated motion control easily through CANopen.

### Cross-Product Integration

Delta's VFD-EC and VFD-C2000 series AC motor drive and ASDA-A2 series AC servo drive and motor are built-in with CANopen communication protocol. The user can realize CANopen communication in these products directly without the use of converter.

### Multi-Axis Motion Control

CANopen communication network supports multi-axis motion control and solves the problem of limited pulse output points on the PLC for pulse control in the past.



## Software Integrating Delta's Communication Products: DCISoft

DCISoft provides graphic module setup and user-friendly interface and supports setup and on-line monitoring for all Delta's Ethernet communication modules.

- For setting up Delta's Ethernet communication products
- Graphical module setup, user-friendly interface
- Auto-search function
- Virtual COM setup interface

## Supporting Delta's Ethernet Communication Products

On-line device list:

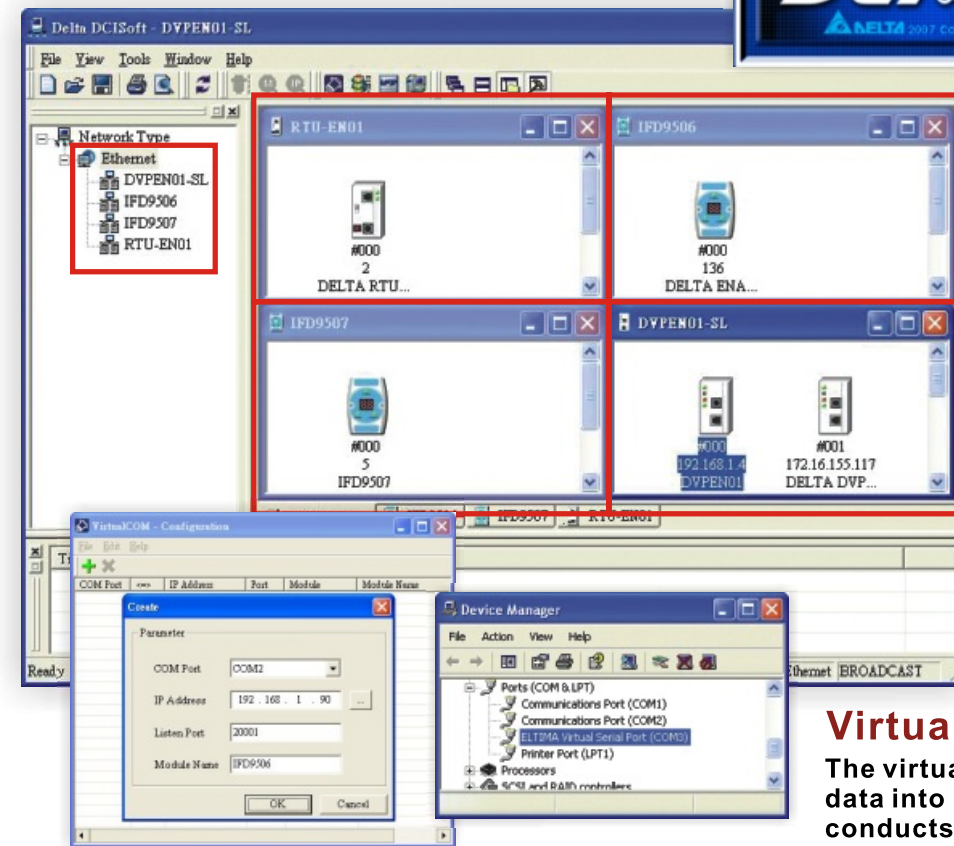

### Virtual COM

The virtual COM converts RS-232 data into network packets and conducts sending and receiving of data through the network.

### On-line Monitoring

Able to remote monitor the values in devices.

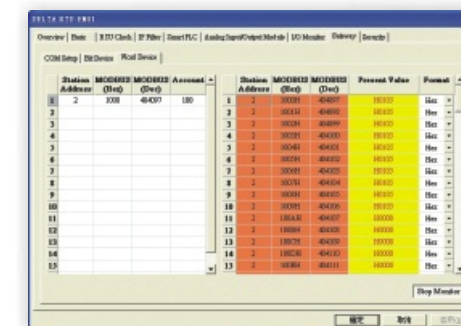





### Software Integrating Delta's Communication Products: **DeviceNet Builder**

DeviceNet Builder is designed specifically for DeviceNet communication. Devices and remote I/O can be planned directly through parameter distribution, and a standard monitoring structure can be built easily.

- DeviceNet configuration software
- Supporting all Delta's industrial automation products (built-in EDS files)
- User can create new EDS files
- Configuring I/O data of all devices on DeviceNet

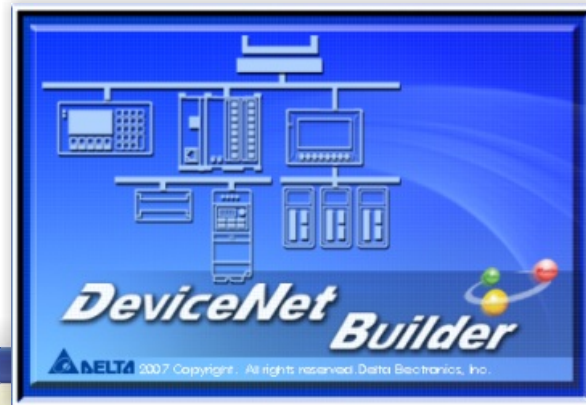

The screenshot shows the Delta DeviceNet Builder software interface. At the top, there is a network diagram with nodes labeled 00 through 11. Below the diagram, there are two windows: 'Node Configuration...' and 'Parameters Edit...'. The 'Node Configuration...' window shows fields for Address (0), Name (RTU-DNET), Vendor ID (799), Device Type (12), Product Code (12288), Major Rev (1), and Min Rev (1). The 'Parameters Edit...' window shows a table of parameters for the selected node.

ID	Type	Parameter Name	Value
1	R	VER	0.000
2	R	ALE	No function
3	R/W	STS	Motor feedback pulse number
4	R/W	MON	CH1 Motor speed(+/-8V/maximum rot
5	R	CM1	0
6	R	CM2	0
7	R	CM3	0
8	R	CM4	0
9	R	CM5	0
10	R	MAP0	0
11	D	M & B1	n

### Software Integrating Delta's Communication Products: **CANopen Builder**

CANopen Builder is designed specifically for CANopen communication, offering the user a handy interface to organize motion control and to greatly enhance the productivity.

- CANopen configuration software
- Supporting all Delta's industrial automation products (built-in EDS files)
- User can create new EDS files
- Configuring I/O data of all devices on CANopen
- Able to conduct the planning of motion control

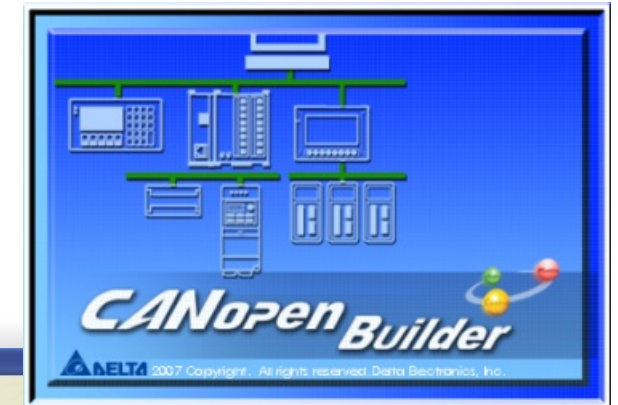

The screenshot shows the Delta CANopen Builder software interface. At the top, there is a network diagram with nodes labeled 001 through 012. Below the diagram, there are two windows: 'Node Configuration...' and 'Node List Setting...'. The 'Node Configuration...' window shows fields for Node-Id (4), Name (VFD-E Drives 230V 2HP), Vendor Id (00001DD), Device Type (00000000), Product Code (00001606), and Revision (00010002). The 'Node List Setting...' window shows a table of nodes and their configurations.

Node-Id	Node Name	Node List
002	VFD-B Drives 230V 10HP	
003	VFD-B Drives 230V 30HP	
004	VFD-E Drives 230V 2HP	
005	VFD-F Drives 230V 30HP	
006	VFD-F Drives 230V 40HP	
007	ASDA-A2 Drive	
008	VFD-EC 230V 1HP	
009	ASDA-A2 Drive	
010	DTA (Pl100) Type2	
011	DTA (TC) S Type	
012	DTA (TC) U Type	



### Delta's Building Automation Solution

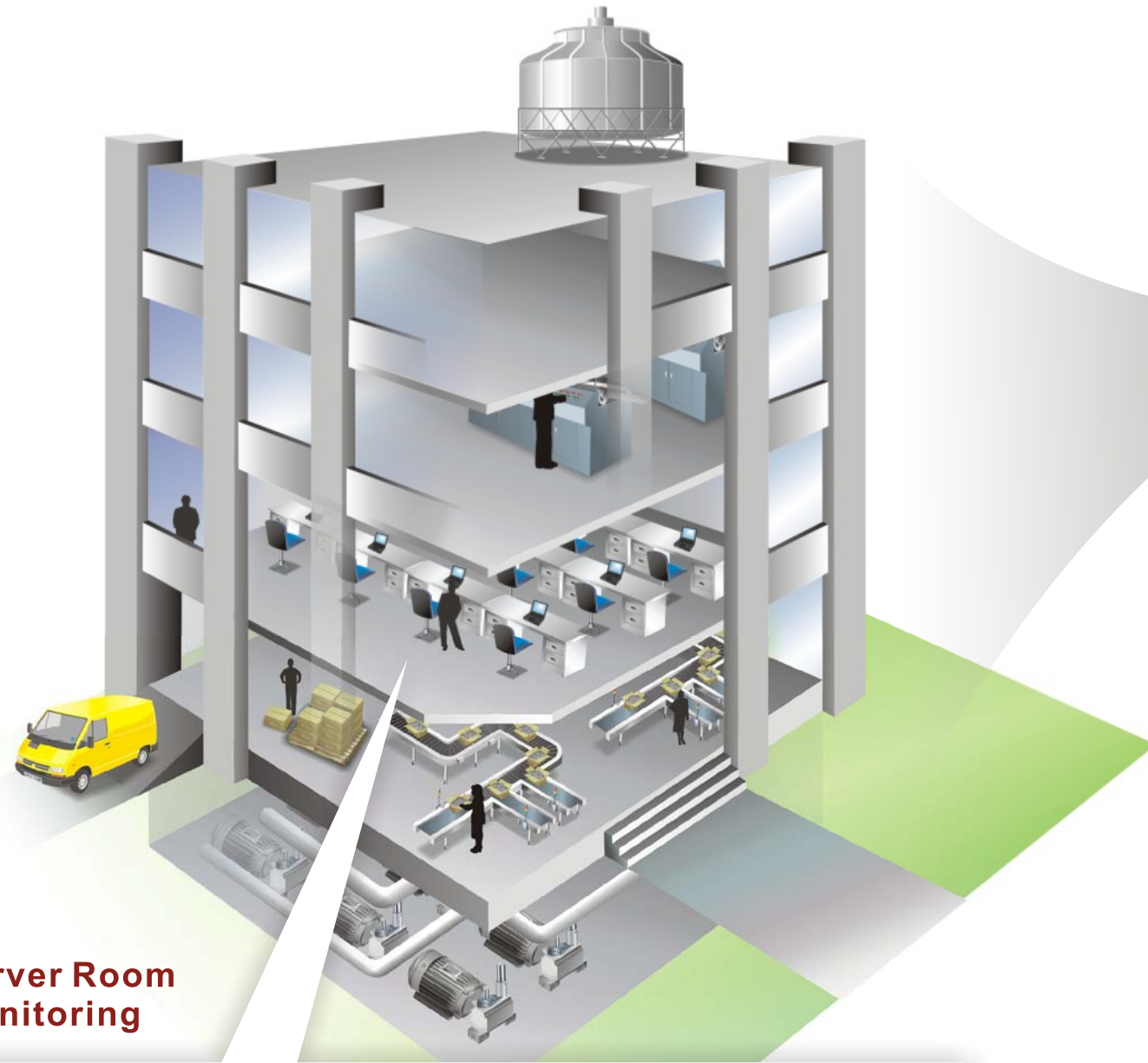

### Server Room Monitoring

### Multi-Machine Synchronous Operation

When many water towers need to run at the same time, the PLC can control many chillers at a time through DeviceNet and make them run or stop as well as controlling the running speed of motor to save energy.

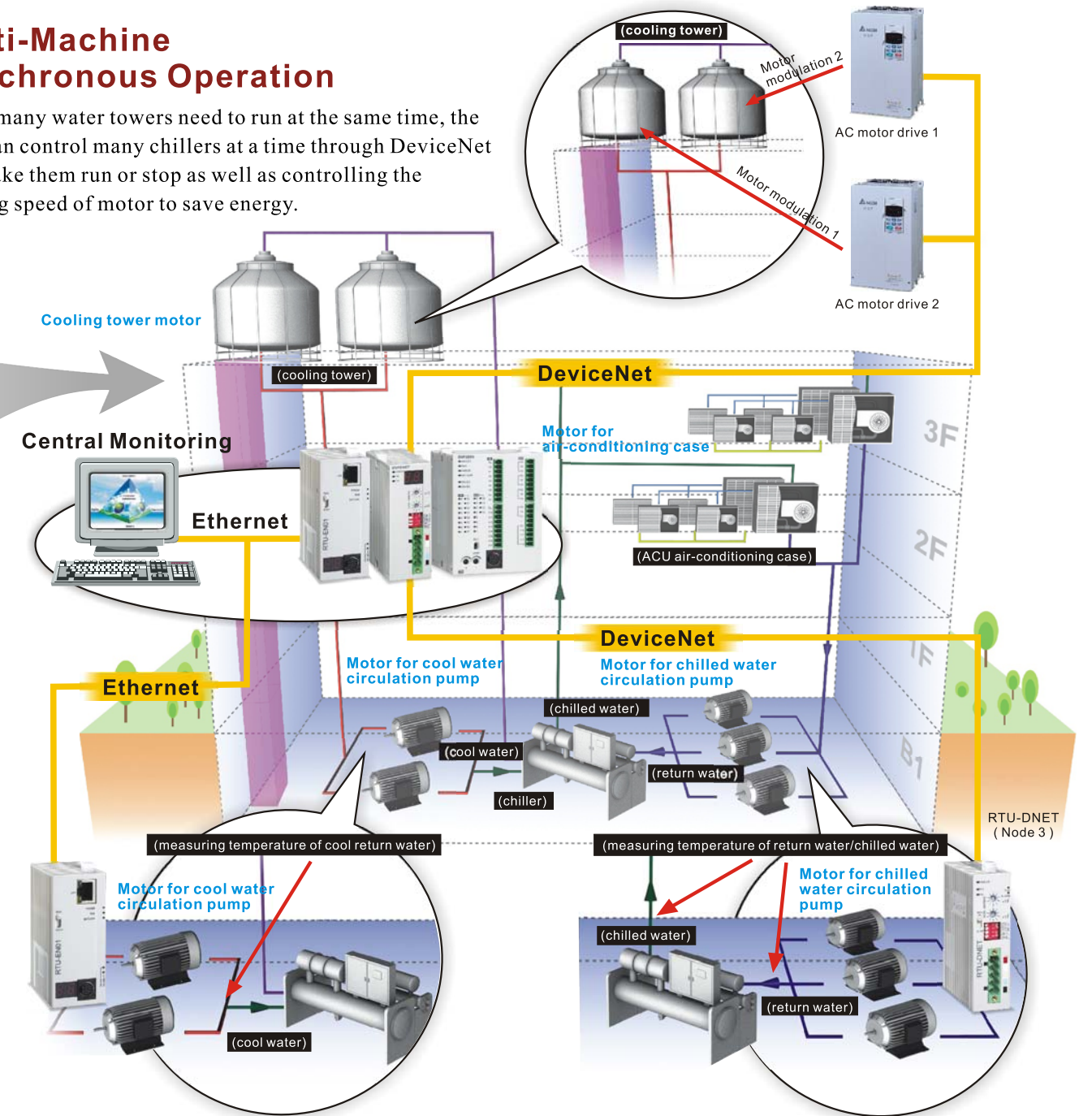

### Variable Frequency Operation of Cool Water Circulation Pump

- The smart PLC function in RTU-EN01 is able to remote modulate the frequency of motor in proportional to the temperature of the cool return water.
- To avoid energy waste on the cool water due to insufficient cool water circulation, RTU-EN01 is able to remote control the variable frequency operation in time.

### Variable Frequency Operation of Chilled Water Circulation Pump

#### Gauging temperature difference

- RTU-DNET is able to gauge the energy load immediately according to the on-site temperature difference between the chilled water pipe and return water pipe to modulate the running speed of the pump.
- When the load demand becomes smaller, the temperature difference between the two pipes will also become smaller, and the modulation motor will run in low speed. When the load demand becomes bigger, the temperature difference will be bigger, leading to acceleration of the modulation motor.

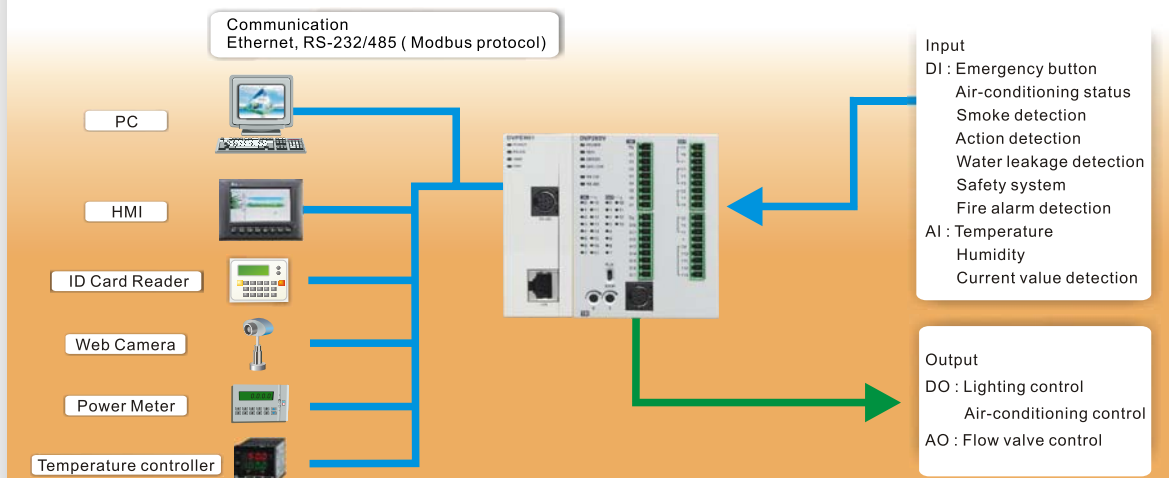



## Delta's Factory Automation Solution

### Enhanced Command Application

#### SPA & GPS commands support solar tracker

- The 2 commands working with GPS can effectively achieve the highest efficiency for the solar tracker.
- GPS positioning function can be applied in the positioning of machine and used for protecting the user's intellectual property.

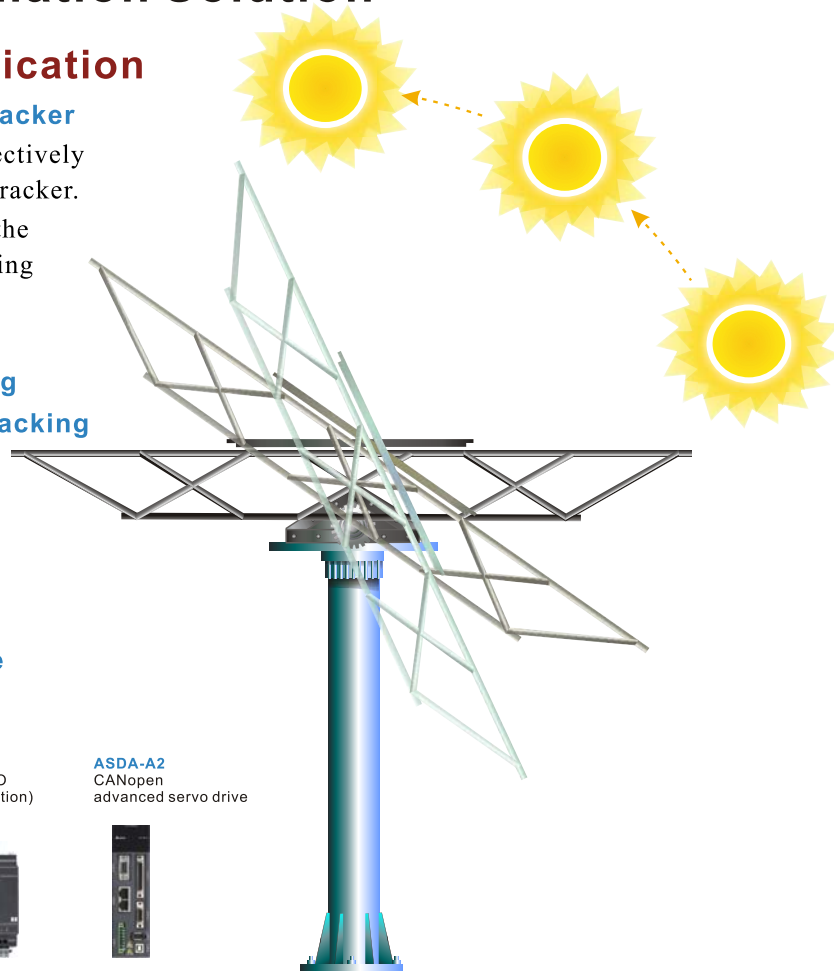
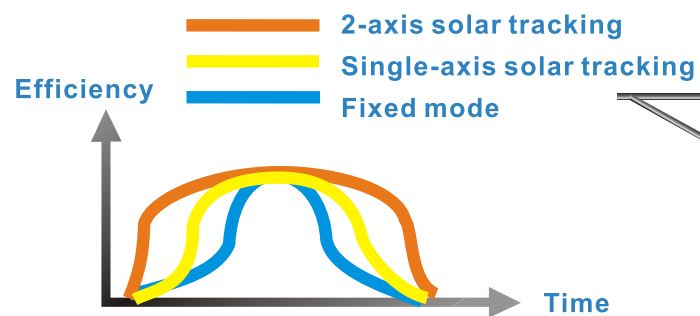

#### Applicable Products

- DVP-SV**  
16 IN/12 OUT
- DVPEN01-SL**  
10/100Mbps Ethernet communication module
- DVP-EX2**  
8 IN/6 OUT/4AI/2AO (MPU, 12-bit resolution)
- ASDA-A2**  
CANopen advanced servo drive

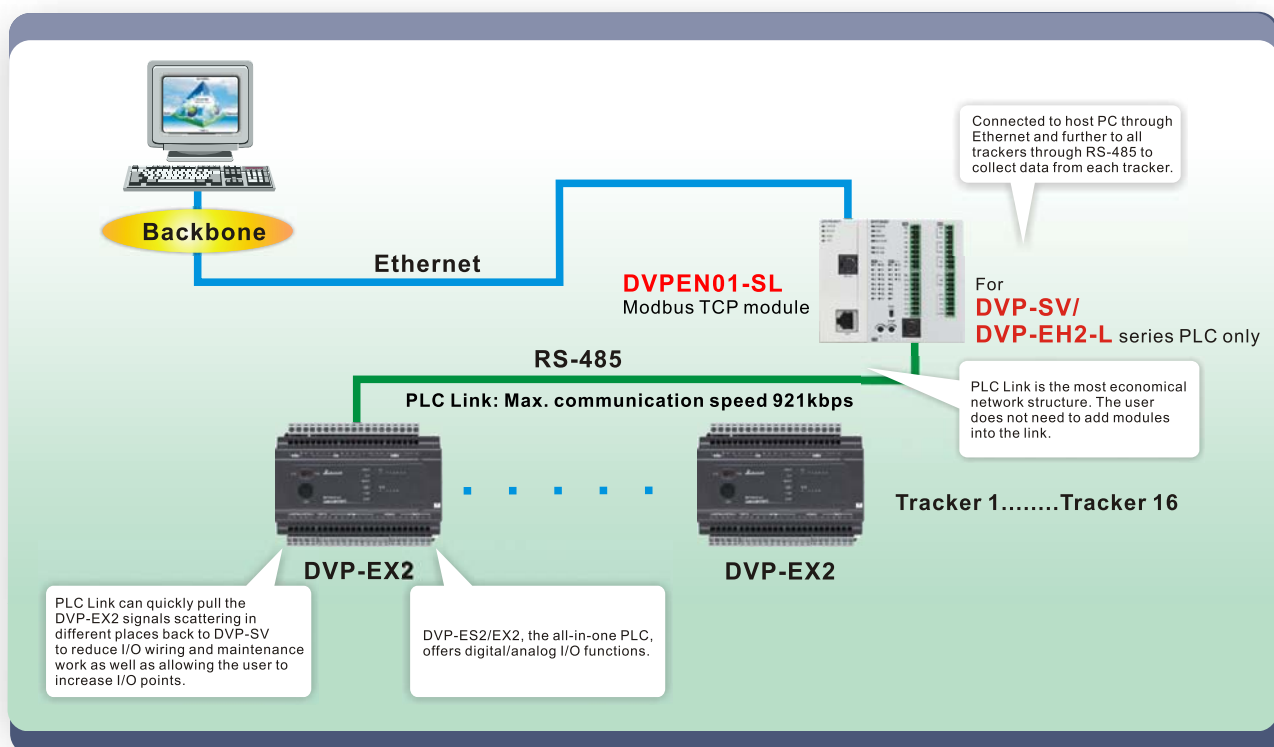

## Planning of Remote I/O Monitoring

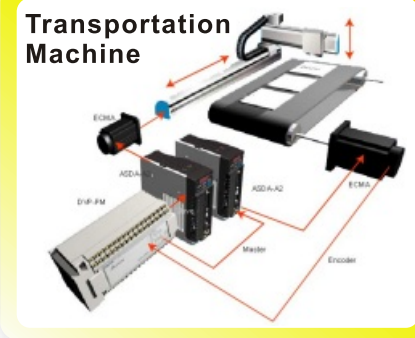
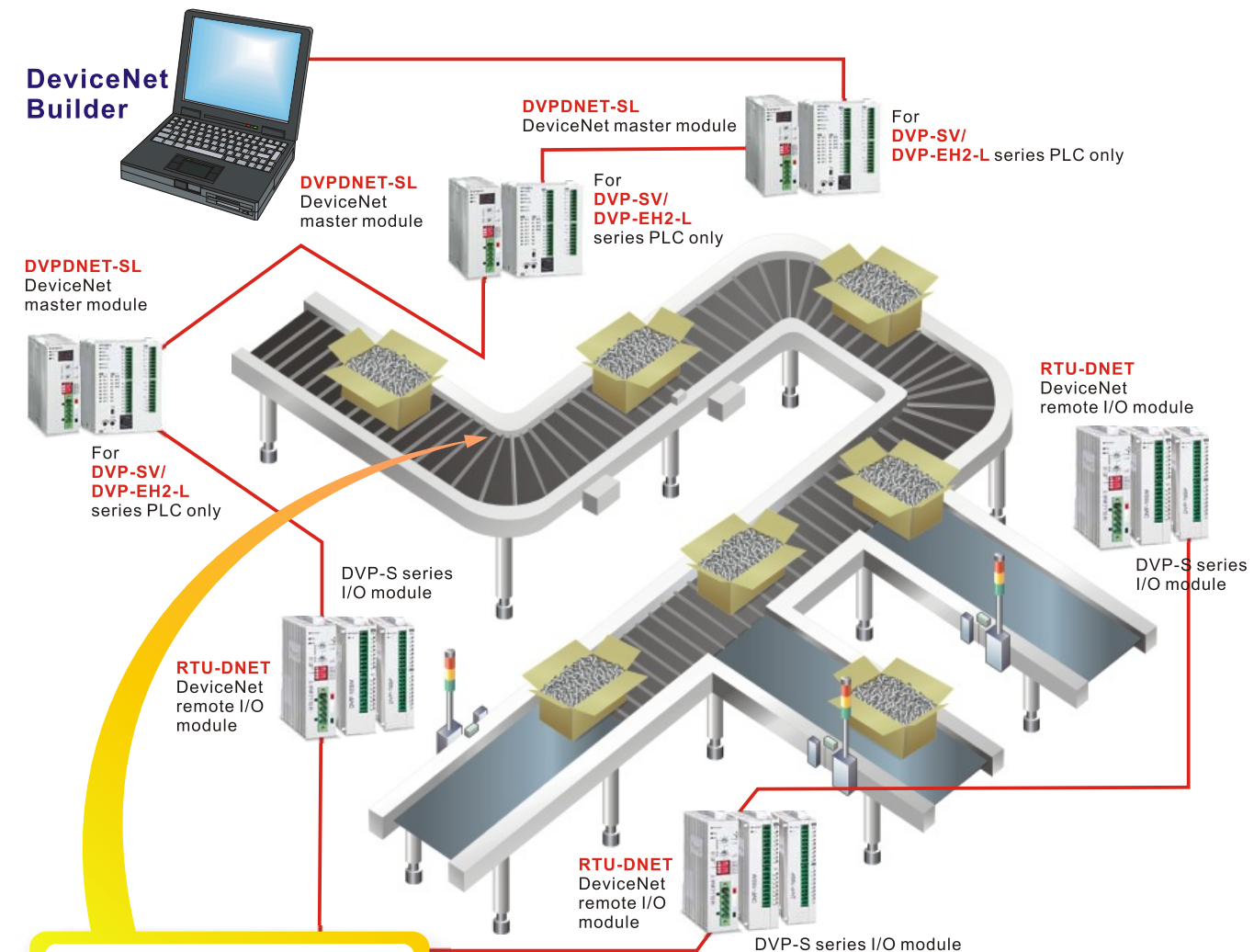

#### Applicable Products

- DVP-SV**  
16 IN/12 OUT
- DVPNET-SL**  
DeviceNet master module for industrial communication
- DVPCOPM-SL**  
CANopen master module for motion communication
- RTU-DNET**  
DeviceNet remote I/O module for industrial communication
- ASDA-A2**  
CANopen advanced servo drive

## Planning for Communication

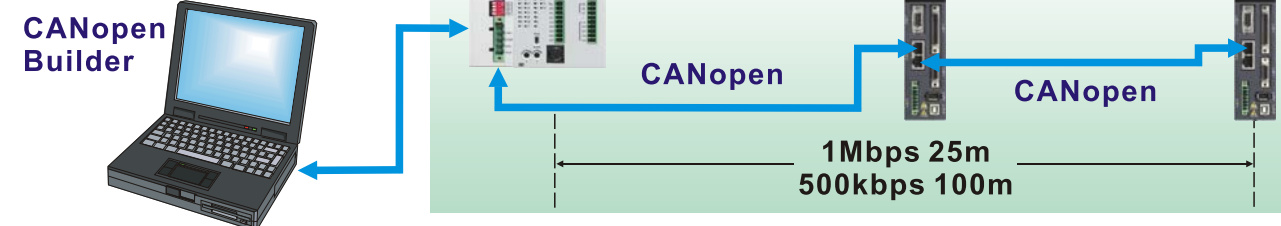



### Delta's Motion Control Solution

The system conducts multi-axis synchronous control with VFD-EC series AC motor drive and ASDA-A2 series AC servo drive through CANOpen, effectively achieving wire-saving, fast and accurate motion.

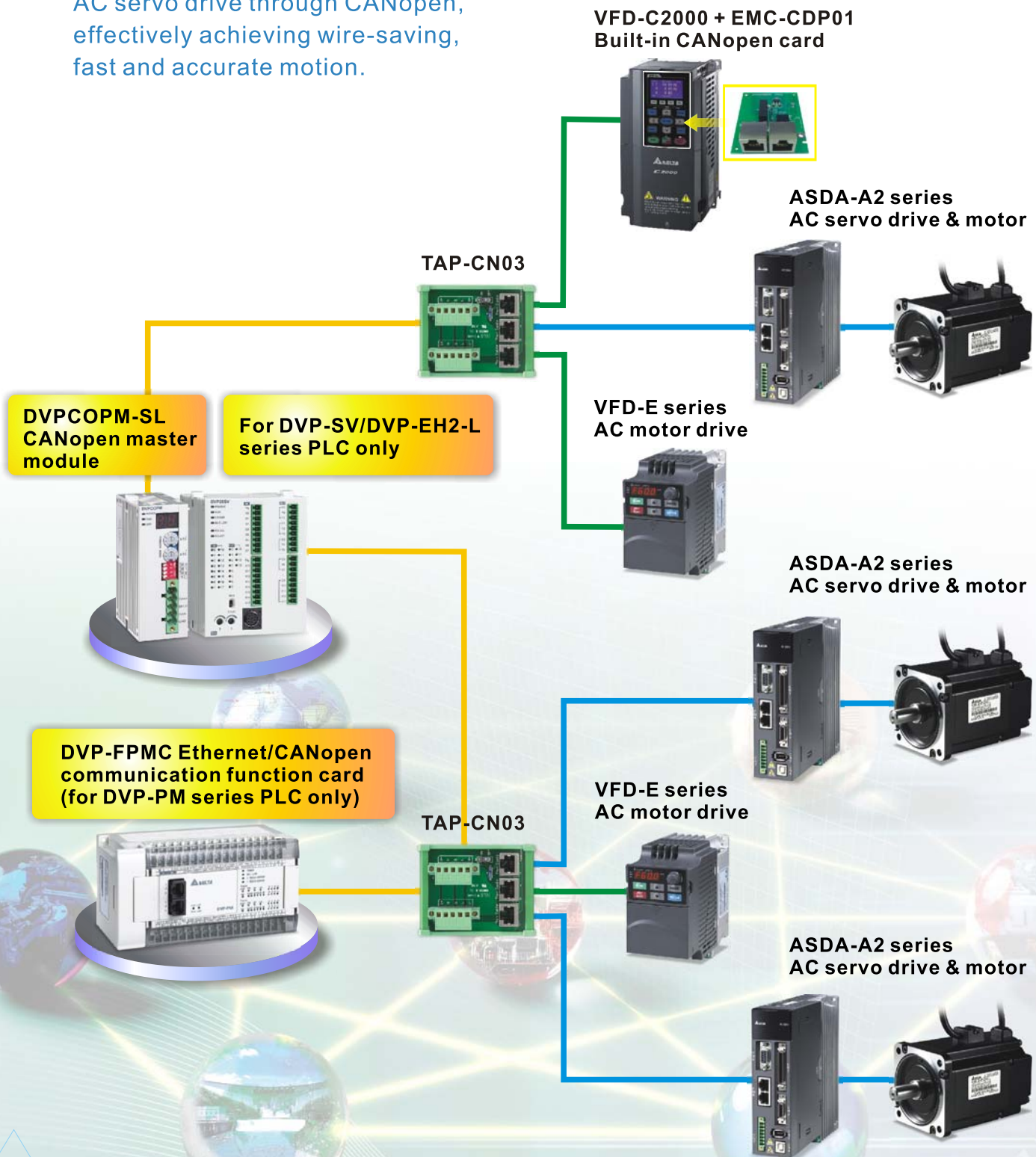

Transportation Machine

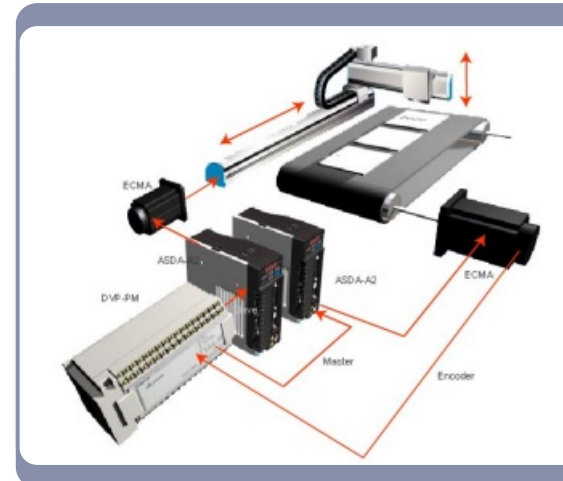

Cutting Machine

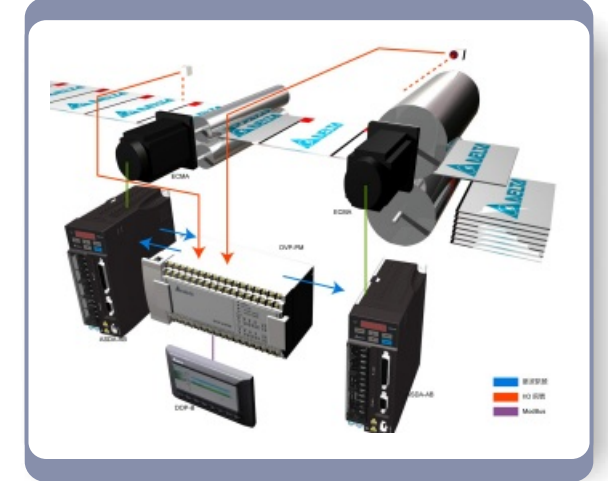

Bar Feeder

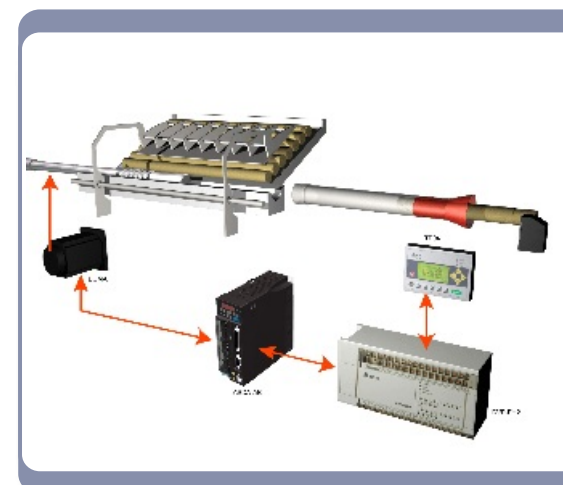

Milling Machine/Lathe

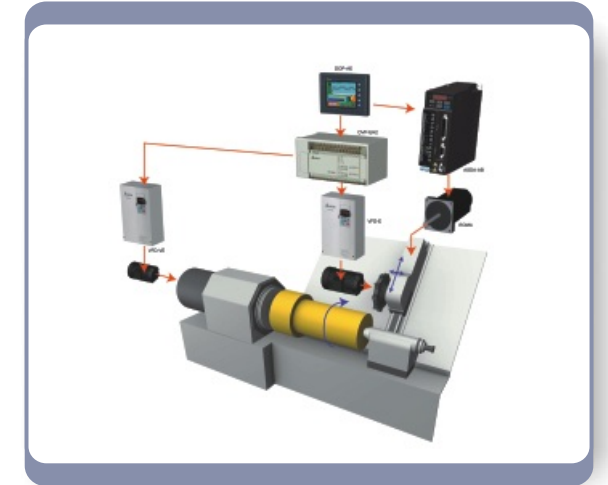

Electro-discharge Machine

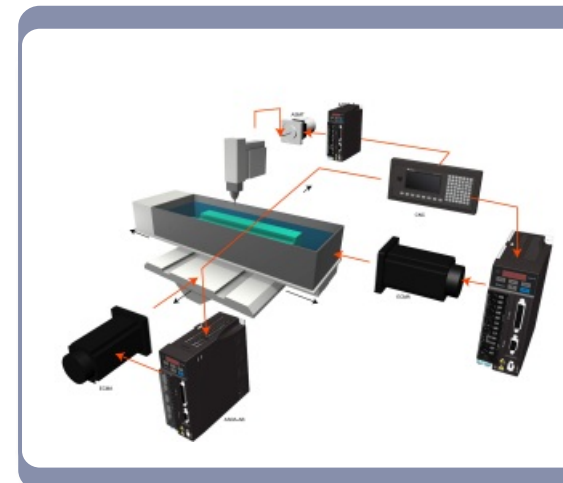

Sawing Machine

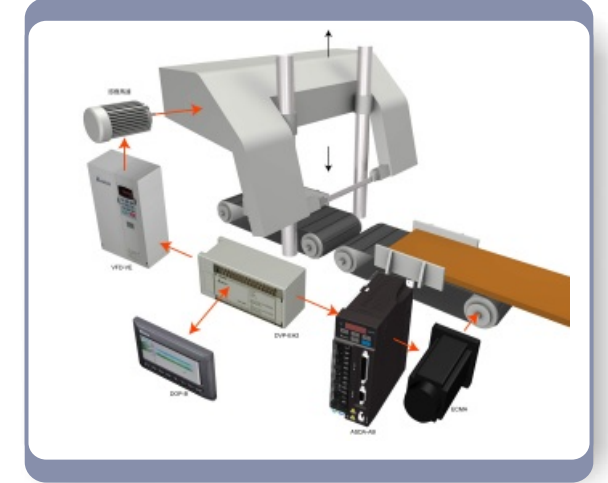





## Ordering Information

### PLC Master Modules

Product	Exterior	Model name	Feature	Certificates
Left-side master modules for DVP-SV/DVP-EH2-L series PLC		DVPEN01-SL	Modbus communication module Ethernet 10/100M Base TX Number of Client connections: 8 Number of Server connections: 16	  
		DVDPNET-SL	DeviceNet scan module Supports max. 500kbps Max. network distance: 500m Number of slaves connected: 63	
		DVPCOPM-SL	CANopen master module Supports max. 1Mbps Max. network distance: 1,000m Number of slaves connected: 110	
Communication card for DVP-PM series PLC		DVP-FPMC	Ethernet/CANopen communication function card	

### PLC Slave Modules

Product	Exterior	Model name	Feature	Certificates
Slave modules for DVP-E series PLC		DVPDT02-H2	DeviceNet slave communication module Supports max. 500kbps	  
		DVPCP02-H2	CANopen slave communication module Supports max. 1Mbps	
		DVPPF02-H2	PROFIBUS DP slave communication module	
Slave modules for DVP-S series PLC		DVPDT01-S	DeviceNet slave communication module Supports max. 500kbps	
		DVPPF01-S	PROFIBUS DP slave communication module	

### Remote I/O Modules

Product	Exterior	Model name	Feature	Certificates
Remote I/O modules		RTU-485	RS-485 remote communication module Connectable to max. 8 analog I/O modules Connectable to max. 128 DI points and 128 DO points	  
		RTU-DNET	DeviceNet remote I/O module Connectable to max. 8 analog I/O modules Connectable to max. 128 DI points and 128 DO points	
		RTU-EN01	Modbus TCP remote I/O module Modbus TCP Slave Ethernet 10/100M Base TX Connectable to max. 8 analog I/O modules Connectable to max. 256 DI/DO points	
		RTU-PD01	Supports PROFIBUS DPV0 Supports max. 12Mbps Connectable to max. 8 AI/AO modules Connectable to max. 256 DI/DO points	

### Industrial Network Converters

Product	Exterior	Model name	Feature	Certificates
USB/RS-485 converter		IFD6500	USB/RS-485 converter Supports 75 ~ 115,200bps Supports hot plugging and plug and play	  
USB/CAN converter		IFD6503	Able to gather CAN messages, decode and display them following DeviceNet and CANopen protocol. Able to set up filter condition and send CAN messages. Supports max. 1Mbps and plug and play.	
USB/RS-485 converter		IFD6530	Offers 9V power supply for parameter storage and page editing through KPC-CC01 (VFD-C2000 keypad) Supports 75 ~ 115,200 bps Supports hot plugging and plug and play	
RS-232/RS-485, 422 converter		IFD8500	RS-232 to RS-422/485 isolated converter	
RS-485/RS-422 isolated repeater		IFD8510	RS-232/422/485 isolated signal regenerator	
RS-232/RS-485, 422 converter		IFD8520	Addressable RS-232 to RS-422/485 isolated converter	
DeviceNet converter		IFD9502	RS-232/485 to DeviceNet converter Supports max. 500kbps	
CANopen converter		IFD9503	RS-232/485 to CANopen converter Supports max. 1Mbps	
Ethernet converter		IFD9506	RS-232/485 to Modbus TCP converter Ethernet 10/100M Base TX 3 sets of external input alarm points RS-485 full isolation	
		IFD9507	RS-232/485 to Ethernet/IP converter 3 sets of external input alarm points RS-485 full isolation	

### Accessories

Product	Model name	Feature
DeviceNet/CANopen network distribution box	TAP-CN01	1-branch distribution box; 121Ω termination resistance; switch
	TAP-CN02	3-branch distribution box; 121Ω termination resistance; switch
	TAP-CN03	3-branch distribution box; RJ-45 connector; 121Ω termination resistance; switch
DeviceNet power supply distribution box	TAP-CP01	Power supply distribution box
DeviceNet / CANopen cable	TAP-CB01	DeviceNet/CANopen trunk cable; thick cable for 305m/rollx
	TAP-CB02	DeviceNet/CANopen drop cable; thin cable for 305m/roll
	TAP-CB03	CANopen drop cable; RJ-45 connector; 0.5m
	TAP-CB04	CANopen drop cable; RJ-48 connector; 1m